



**1980**

# **CONWAY TRAILERS**

**ERECTION INSTRUCTION IN PICTURES**

**GENERAL HINTS FOR CAMPING**

**CARE AND PROTECTION OF YOUR CANVAS**

**MAINTENANCE DETAILS**

# CONWAY CROWN, CROWN DE LUXE and CORNICHE

## ERECTION INSTRUCTIONS

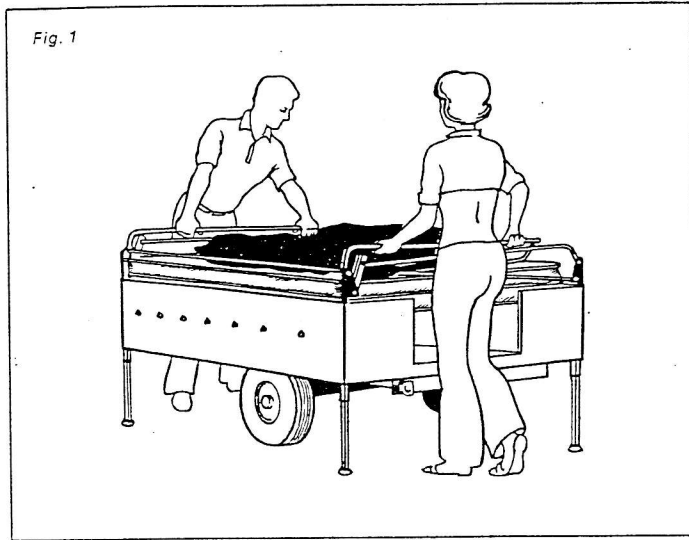

1. Unhitch trailer from car. Position on as level ground as possible. Drop down the 4 trailer corner jacks.
2. Remove Cover (See Fig. 1.)
3. Remove Kitchen.

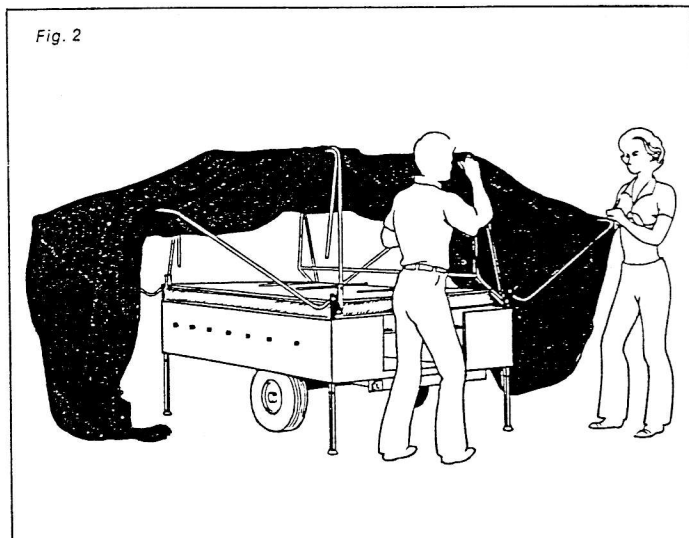

4. Swing over to either side to 4 roof support poles (See Fig. 2.)

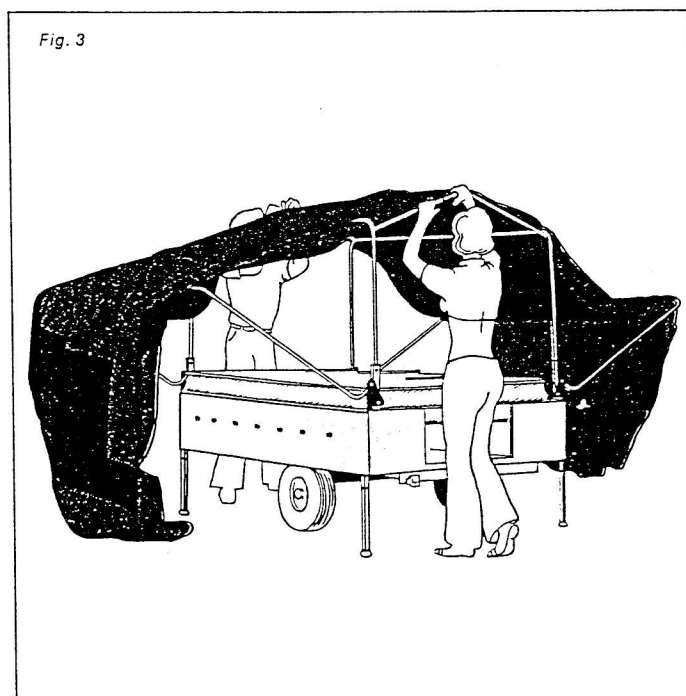

5. Lift up the 2 hinged arms to form the 5th roof support pole. (See Fig. 3.) Connect by means of the spring button clip.
6. Extend each of the 4 cabin support poles by pushing upwards simultaneously at front and back. (See Fig. 4.)

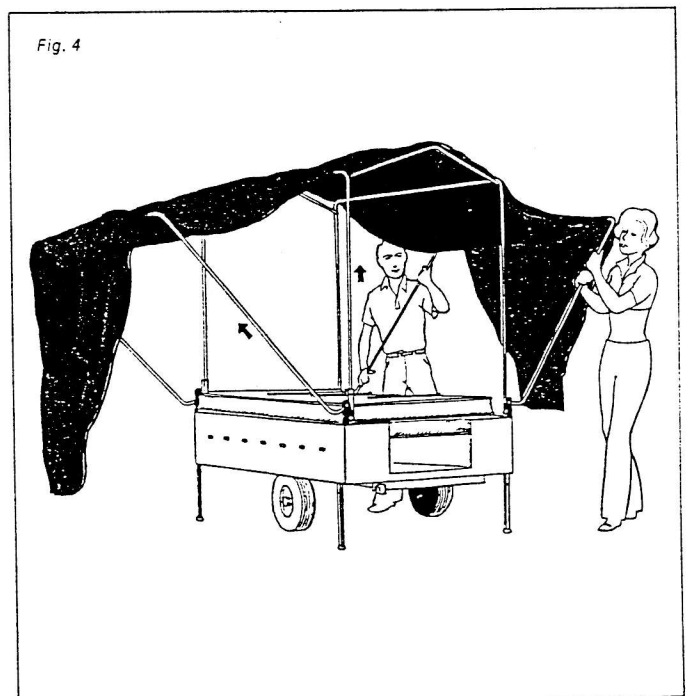

Fig. 5

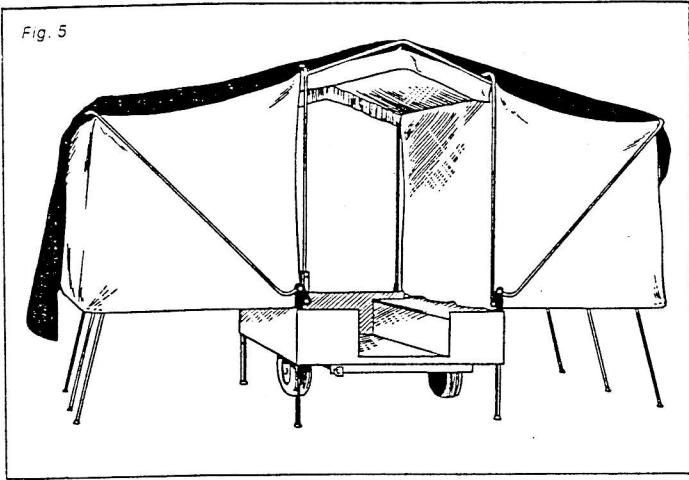

Fig. 6

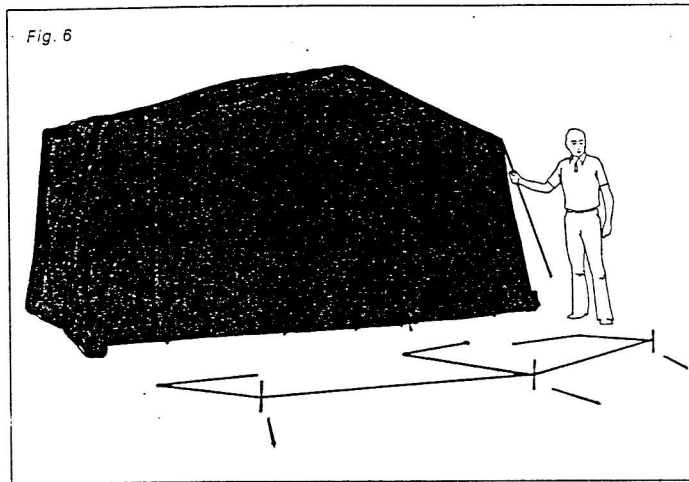

Fig. 7

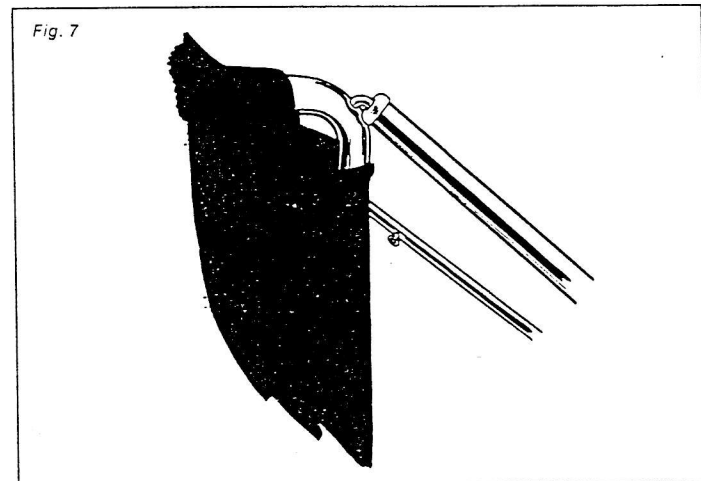
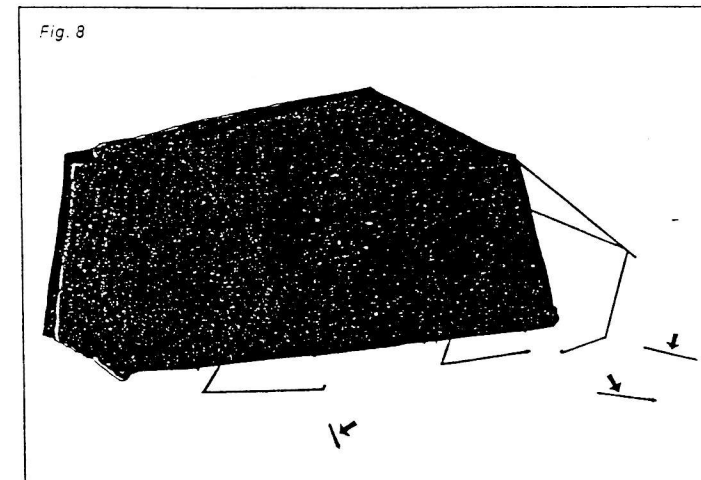
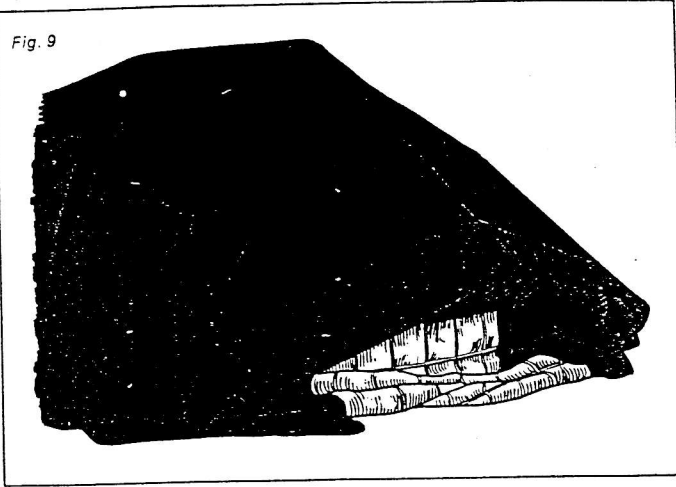

Fig. 8



7. Initially locate the small button clip in the centre of the bank of 5 holes in each pole. These can be adjusted as necessary when pegging out.
8. Fold over each bed board and mattress to each side. Check that each bed leg is securely located and adjust as necessary.
9. Release elastic bands restraining inner tents and mattresses, and clip the inner tents to the framework. (See Fig. 5.)
10. Pull down front and rear walls of cabin canvas, but leave the extension canvas folded back over the roof.
11. Remove the extension frame from its bag and assemble the front 'A' frame and legs on the floor. (See Fig. 6.) Leave the bottom section of each leg unjointed.
12. Assemble the 3 long adjustable roof poles, and connect to the cabin frame by means of the hooks in the end of each pole. (See Fig. 7.) The 1 small hook is for the central roof pole.
13. Holding the central roof pole in position, raise the front 'A' frame and connect. Repeat for the 2 side roof poles. (See Fig. 8.) Leave the adjustable thumbscrews loose at this stage.

Fig. 9



14. With the legs still in the lower position, pull forward the extension canvas and locate over the front angles. (See Fig. 9.)  
CROWN:-Fit the 3 short canopy poles.  
CORNICHE:-Tie internal tie tapes to front corners.
15. Adjust the 3 extension roof poles until canvas is taut, then tighten the thumbscrews.

Fig. 10

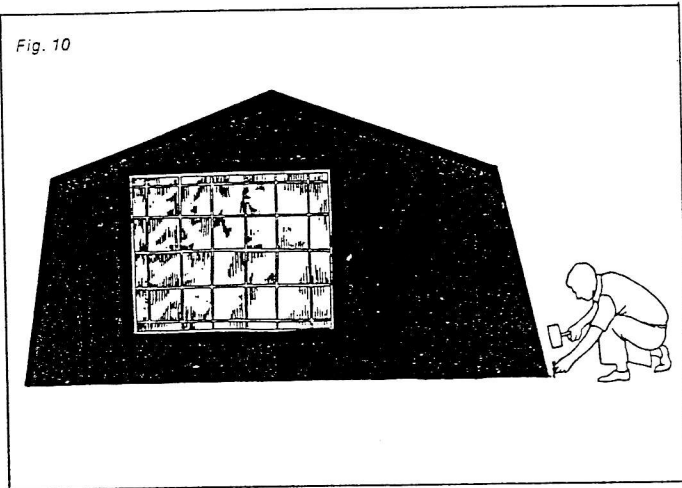

16. Connect lower sections of the extension legs bringing them to their full height. (See Fig. 10.)
17. Peg out in the following sequence with all zips closed.
  - (1) Rear Corners, ensure that the towbar gusset is tied.
  - (2) Front Corners.
  - (3) Centre sides in line with inner wall.
  - (4) All intermediate points.

Fig. 11

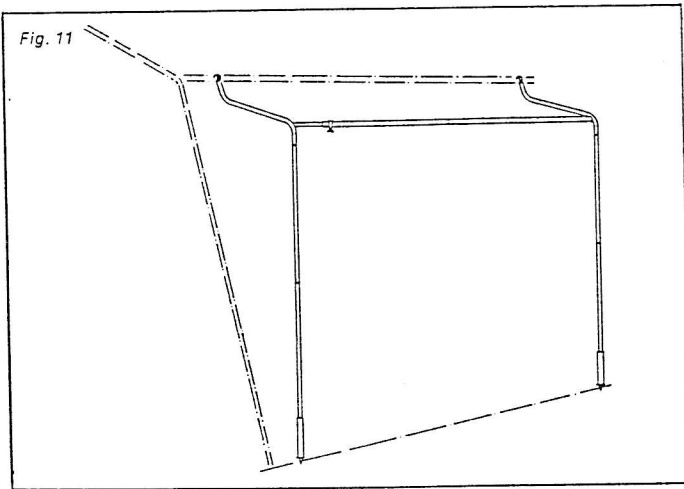

#### CORNICHE ONLY

18. The Kitchen extension should be added between pegging out point (3) and (4) (See Fig. 11.)

Fig. 12

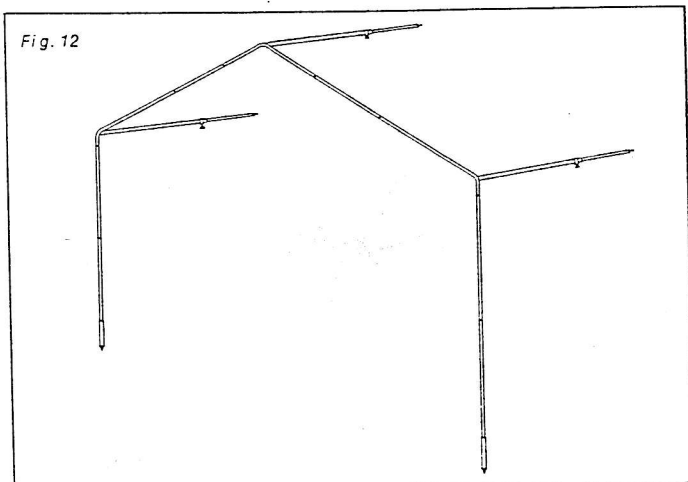

19. The sun canopy can be added after instruction 15, or when pegging out is complete. (See Fig. 12.) The sun canopy framework is initially packed separately in a plastic bag. The sun canopy should be dismantled in extreme conditions, and the canvas rolled back.

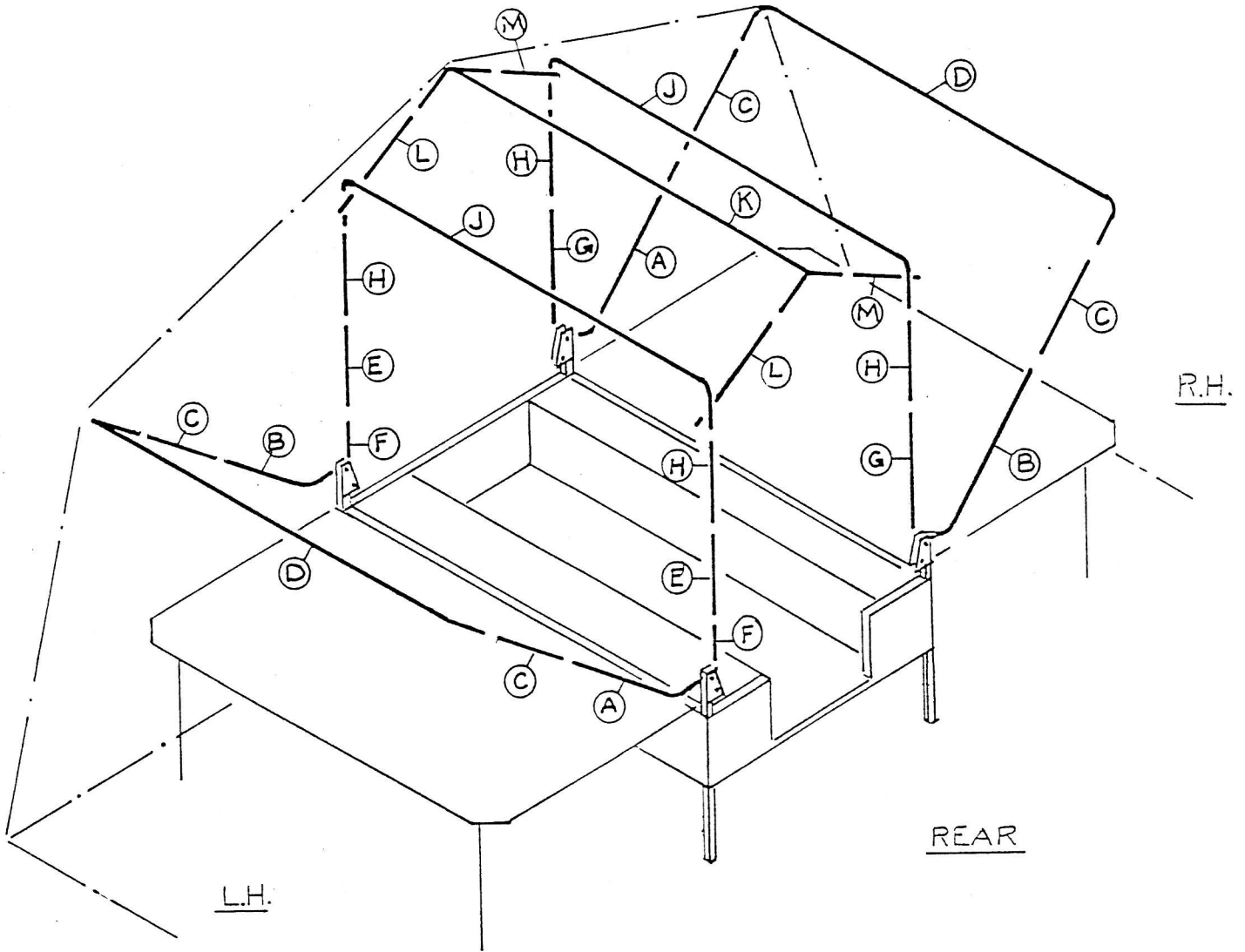

CABIN FRAME FOR CORNICHE AND  
CROWN DE-LUXE TRAILER TENTS.

LIST OF PARTS FOR ONE CABIN.

REF	PART NO	Nº/TENT	DESCRIPTION
A	80335	2	LOWER CABIN POLE L.H.REAR & R.H.FRONT
B	80336	2	" " " " L.H.FRONT & R.H.REAR
C	80337	4	UPPER " " " " L.H.& R.H.
D	80338	2	CABIN ROOF POLE L.H. & R.H.
E	80339	2	LOWER CENTRAL CABIN POLE. L.H. REAR & FRONT
F	80340	2	HINGE FRAME BRACKET
G	80340	2	LOWER CENTRAL CABIN POLE. R.H. REAR & FRONT
H	80341	4	UPPER " " " " L.H.&R.H. REAR & FRONT
J	80342	2	CENTRAL CABIN ROOF POLE. L.H.&R.H.
K	80343	ONE	CABIN RIDGE POLE
L	80344	2	RIDGE POLE TIE PIECE WITH BUTTON CLIP-L.H.
M	80345	2	" " " " WITHOUT " " " -R.H.