

FOLDING CAMPER ERECTING INSTRUCTIONS - CHALLENGER ERECTING INSTRUCTIONS

The following instructions are intended as a step-by-step guide to help you erect your Conway unit. Please read your owners manual thoroughly where you will find other helpful information within the section on pitching.

- Main Cabin 1-16
- Awning Instructions 17-22
- Sun Canopy Instructions 23-28

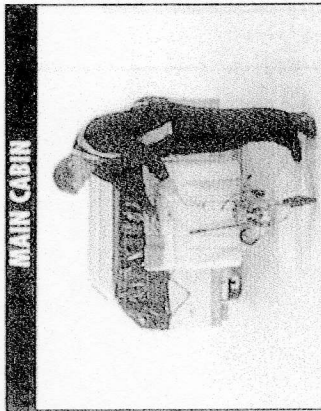

1. Apply handbrake and level trailer by means of jockey wheel.

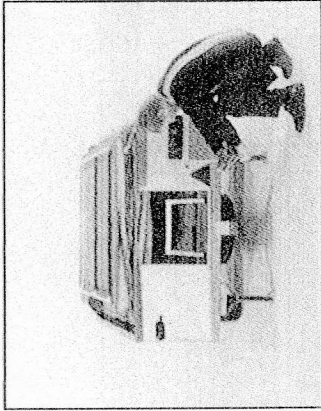

2. Remove waterproof cover. Open rear door, take out winding handle, lower four corner steadies.
NOTE: Corner steadies should not be used as jacks to level trailer.

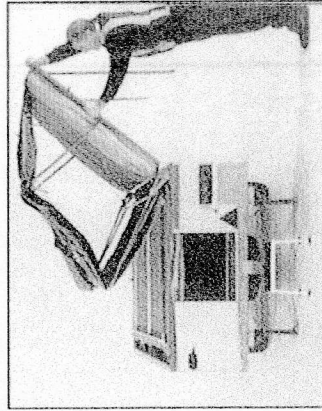

3. Lift over the top bed board and ensure that the legs hinge correctly to ground.
Note: 2002 models have bed lever arms fitted to assist with opening and folding.

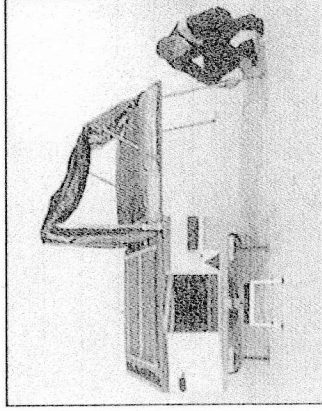

4. Adjust height of bed legs if necessary to level bed.



CHALLENGER ERECTING INSTRUCTIONS CONTINUED

Freedom for Life

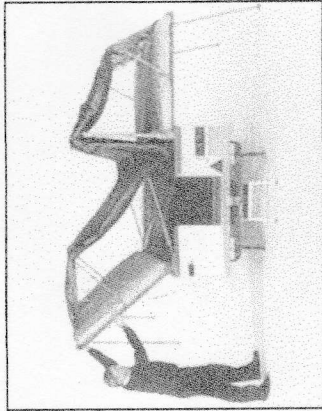

5. Repeat operation for second bed board and level if necessary.

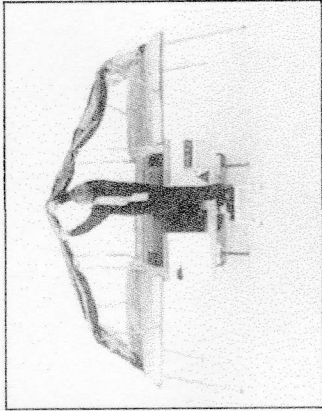

6. Release left and right hand centre "A" frame parts from rubber retaining bands and button clip together at the centre.

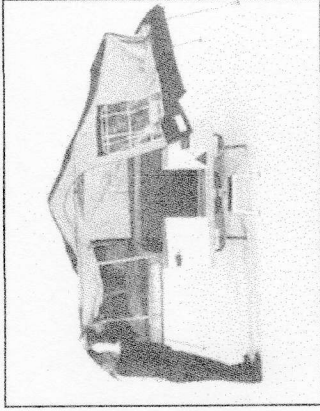

7. Pull canvas down from the roof at the front of the trailer. Open the door zip at the rear of the trailer.



8. Step inside the trailer, push out bed end supports to first button clip and repeat for the central support uprights back and front.

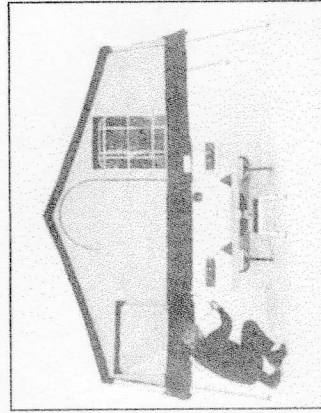

9. Close trailer and canvas doors. Pull canvas over bed ends and hook elasticated canvas sides to cleats located under bed board.

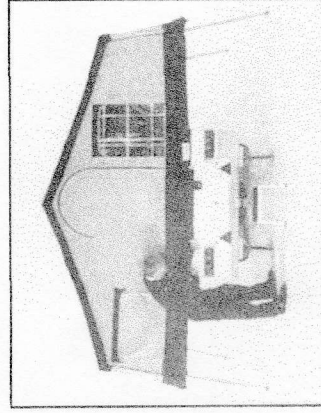

10. Attach velcro strip at the front and back of the tent to plastic moulding fastened to trailer body. Step back inside the trailer and adjust bed end and roof support poles as necessary to tension canvas.



Freedom for Life

CHALLENGER ERECTING INSTRUCTIONS CONTINUED



11. Hinge over kitchen unit, locating sink outlet in base. Connections for gas, water and drain outlet at front of the trailer by the drawbar.



12. Unscrew locking screws at both sides of the kitchen unit. Lift up one side of the kitchen top section as shown.



13. Lift up other side and refix locking screws to secure kitchen top section to base unit.



14. Unclip waterproof protective cover from mattress and roll back, unbuckle webbing mattress retaining straps. Fit left hand inner tent and separate roof liner by hooking to roof poles.

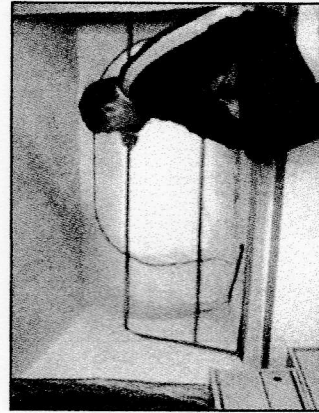

15. Fit right hand inner tent ensuring back rest support poles fit through slot in base of inner tent, extend frame and then hinge down flat and fit mattresses for use as a bed.

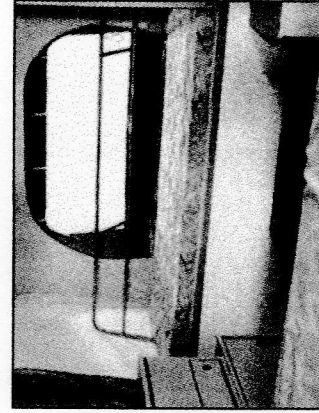

16. To convert right hand bed to a bench seat, hinge up back-rest support frame and lower top bar to short position. Fit the two support poles in brackets on the bed board and clip to bar. Reverse procedure to fold down.



CHALLENGER AWNING INSTRUCTIONS

Freedom for Life

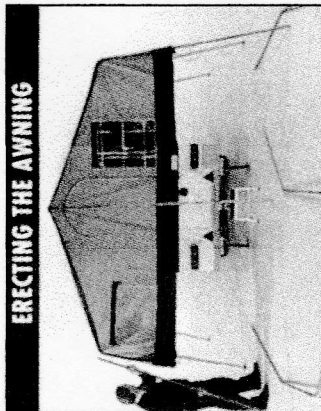

17. Take awning frame from bag and layout flat as shown. Assemble front "A" frame and hook in three roof support poles to main cabin.

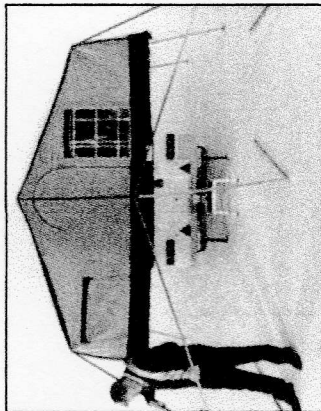

18. Fit front "A" frame with legs 'broken' and connect to centre roof pole then connect two side roof poles to front frame.

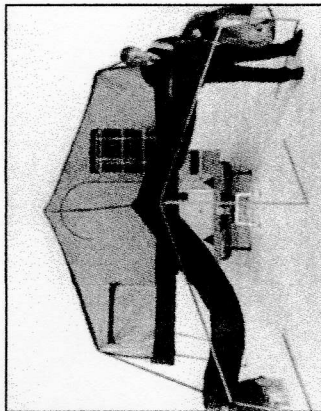

19. Take canvas from bag and lay out over roof poles.

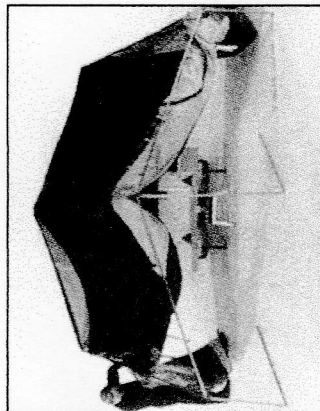

20. Pull canvas up roof poles and zip awning canvas to main cabin canvas, ensure canvas zip cover is pulled over zip.

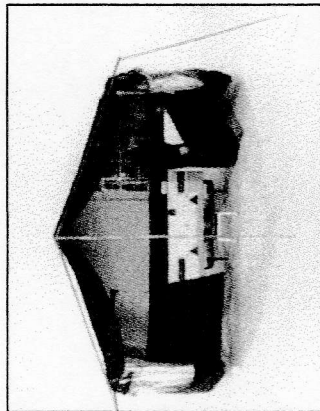

21. Lift front frame to full height, zip on awning skirt and fit draught skirt.

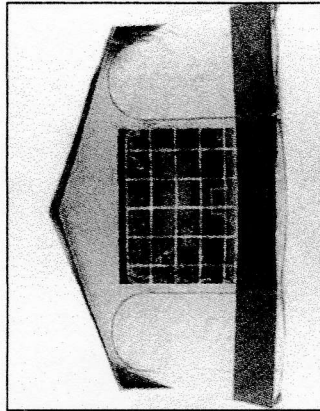

22. Pull canvas over front frame, fit stub canopy poles then tension roof poles, peg out canvas, remembering to peg out elasticated zip cover.



CHALLENGER SUN CANOPY INSTRUCTIONS

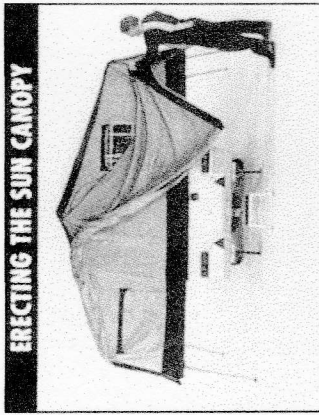

23. Zip on sun canopy to main cabin canvas and let canvas hang down over door way.

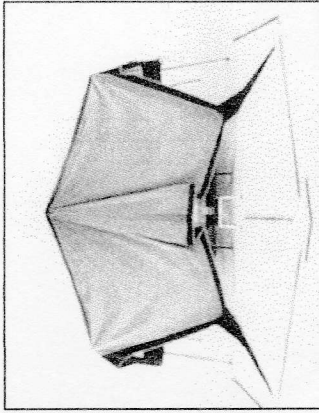

24. Lay out canopy frame as shown.

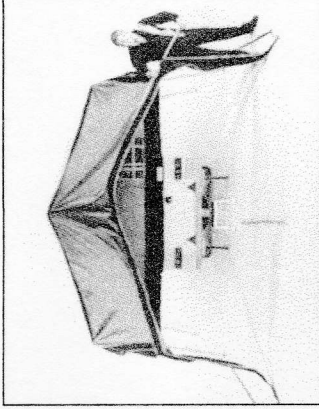

25. Connect centre apex pole to side apex poles and feed through sleeve at front of canopy.

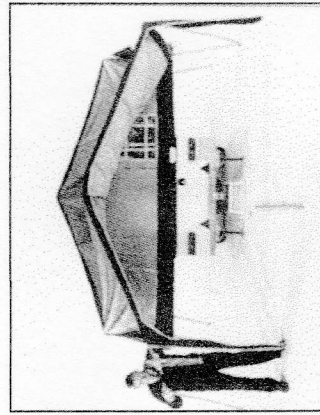

26. Connect adjustable legs to apex poles.

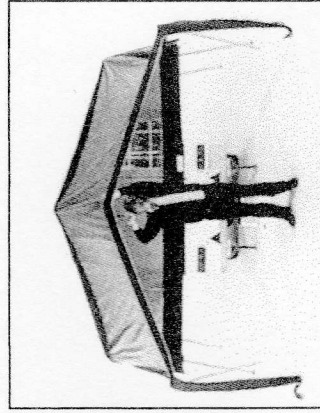

27. Hook in centre roof pole to cabin frame, fit spike end into centre apex pole and tension.

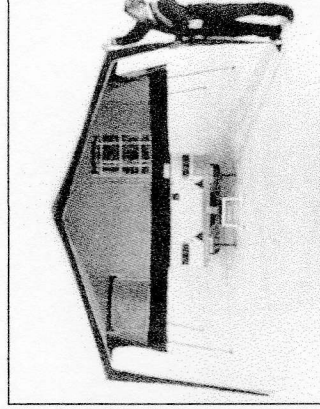

28. Ensure eyelets are over spiked corners, peg canvas and guy out from spikes.



2002 CHALLENGER CABIN, BODY, SUN CANOPY & AWNING FRAME PARTS

Freedom for Life

NOTE: Due to model differences it is vital to quote the Model Type and both Model No. and Serial No. visible on the Trailer Chassis Plate fitted to the nearside front cover, when ordering Cabin, Sun Canopy, or Extension Frame Parts.

Cabin Frame parts: REF: CL1072-A

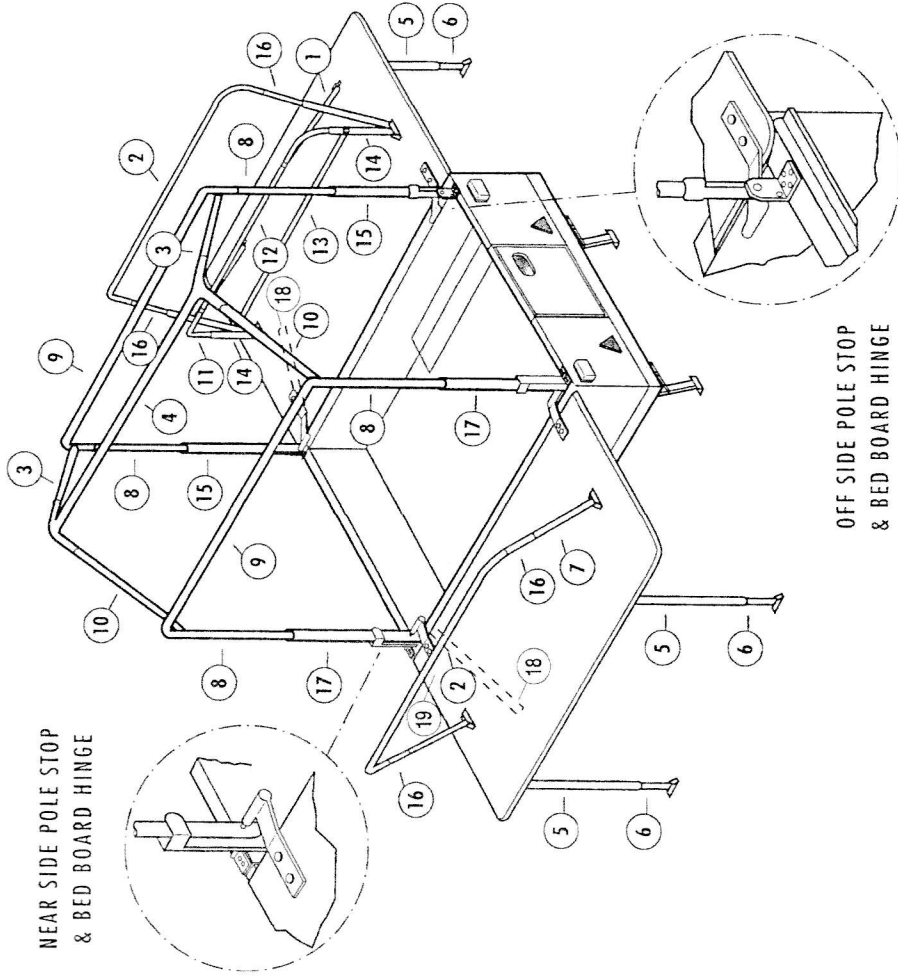

REF NO.	QTY	DESCRIPTION
1	2	BACKREST STAY
2	2	BED FRAME BOW
3	2	TIE POLE - CRIMPED
4	1	RIDGE POLE
5	4	BED SUPPORT LEG - UPPER POLE
6	4	BED SUPPORT LEG - LOWER POLE
7	4	BED FRAME UPRIGHT
8	4	CABIN FRAME UPRIGHT - TOP
9	2	CABIN FRAME BOW
10	2	TIE POLE
11	2	BACKREST - CORNER
12	1	BACKREST - CENTRE POLE
13	1	BACKREST - TIE POLE
14	2	BACKREST - UPRIGHT
15	2	CABIN FRAME UPRIGHT
16	4	BED FRAME UPRIGHT - TOP
17	2	FRAME UPRIGHT - FRONT/REAR
18	2	BED LIFTER/ASSISTER ARMS
19	2	BED LIFTER/ASSISTER CABLES

NOTES: Poles 2, 16/8, 9/3, 4 are crimped together.



CHALLENGER BODY & KITCHEN PARTS

REF NO.	QTY	DESCRIPTION
1	2	NEAR & OFF SIDE "A" FRAME MEMBER
2	1	CHASSIS
3	4	CORNER STEADY
4	1	REAR DOOR
5	2	TRIANGLE
6	2	REAR COMBINATION LIGHT - NEAR SIDE & OFF SIDE
7	2	BED BOARD FRAME
8	2	BED BOARD
9	1	KITCHEN BASE UNIT
10	1	KITCHEN TOP UNIT
11	1	SIDE SPLASH GUARD - LEFT HAND
12	1	SIDE SPLASH GUARD - RIGHT HAND
13	1	NEAR SIDE REAR CORNER LOCKER
14	1	OFF SIDE REAR CORNER LOCKER
15	1	NEAR SIDE BED BOARD HINGE - RIGHT HAND
16	1	NEAR SIDE BED BOARD HINGE - LEFT HAND
17	1	NEAR SIDE HINGE MOUNTING PLATE - RIGHT HAND
18	1	NEAR SIDE HINGE MOUNTING PLATE - LEFT HAND
19	1	NEAR SIDE POLE STOP UPRIGHT - RIGHT HAND
20	1	NEAR SIDE POLE STOP UPRIGHT - LEFT HAND
21	1	OFF SIDE HINGE MOUNTING PLATE AND LEFT HAND POLE STOP
22	1	OFF SIDE HINGE MOUNTING PLATE AND RIGHT HAND POLE STOP
23	1	OFF SIDE BED BOARD HINGE - LEFT HAND
24	1	OFF SIDE BED BOARD HINGE - RIGHT HAND
25	1	TABLE LOCATION BRACKET (DISCONTINUED)
26	2	BACKREST LOCATION BRACKET
27	2	BACKREST ANCHOR BRACKET
28	1	BODY ASSEMBLY INCLUDING FLOOR

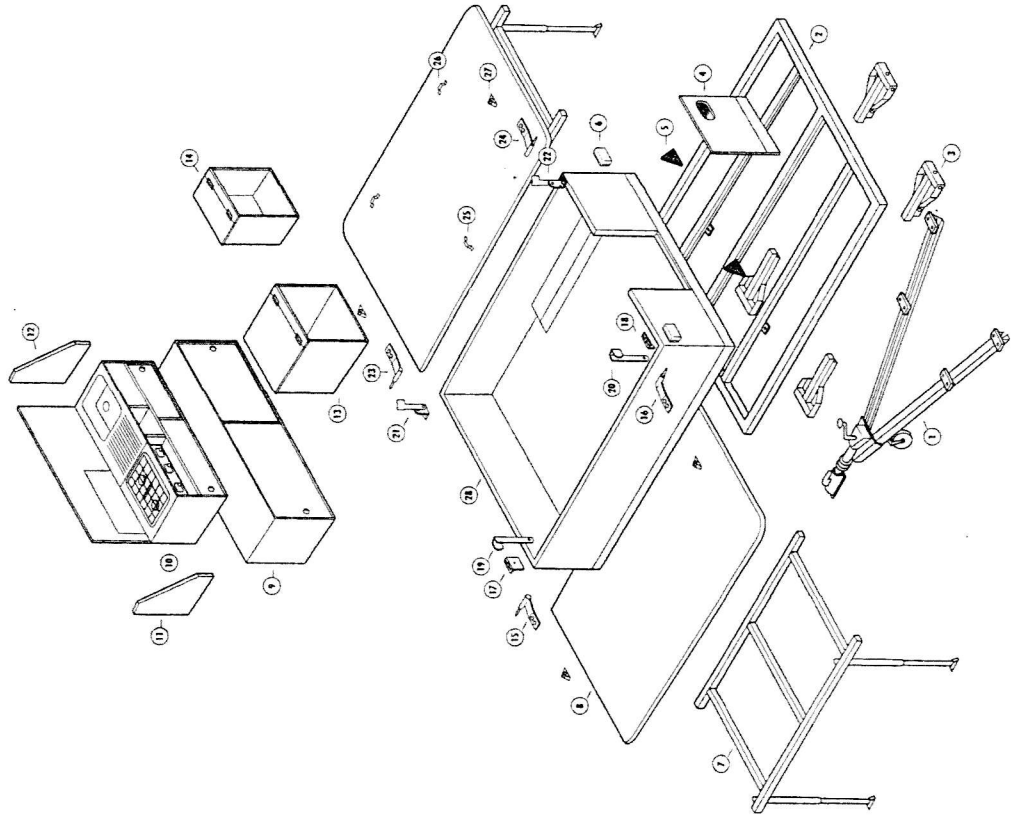



2001/02 CHALLENGER AWNING FRAME PARTS - REF.CL1066-A

REF NO.	QTY	DESCRIPTION
1	1	HOOKED POLE - SHORT
2	2	HOOKED POLE - LONG
3	3	ROOF POLE ADJUSTER
4	3	ROOF POLE
5	3	ADJUSTABLE FOOT
6	2	SUPPORT LEG - LOWER
7	2	SUPPORT LEG - UPPER
8	2	CENTRE BRANCH
9	1	SUPPORT LEG - CENTRE
10	1	SUPPORT LEG - LOWER
11	1	SUPPORT LEG - UPPER
12	1	CENTRE BRANCH - 5 WAY
13	1	LEFT HAND BRANCH - 4 WAY
14	1	RIGHT HAND BRANCH - 4 WAY
15	3	STUB CANOPY

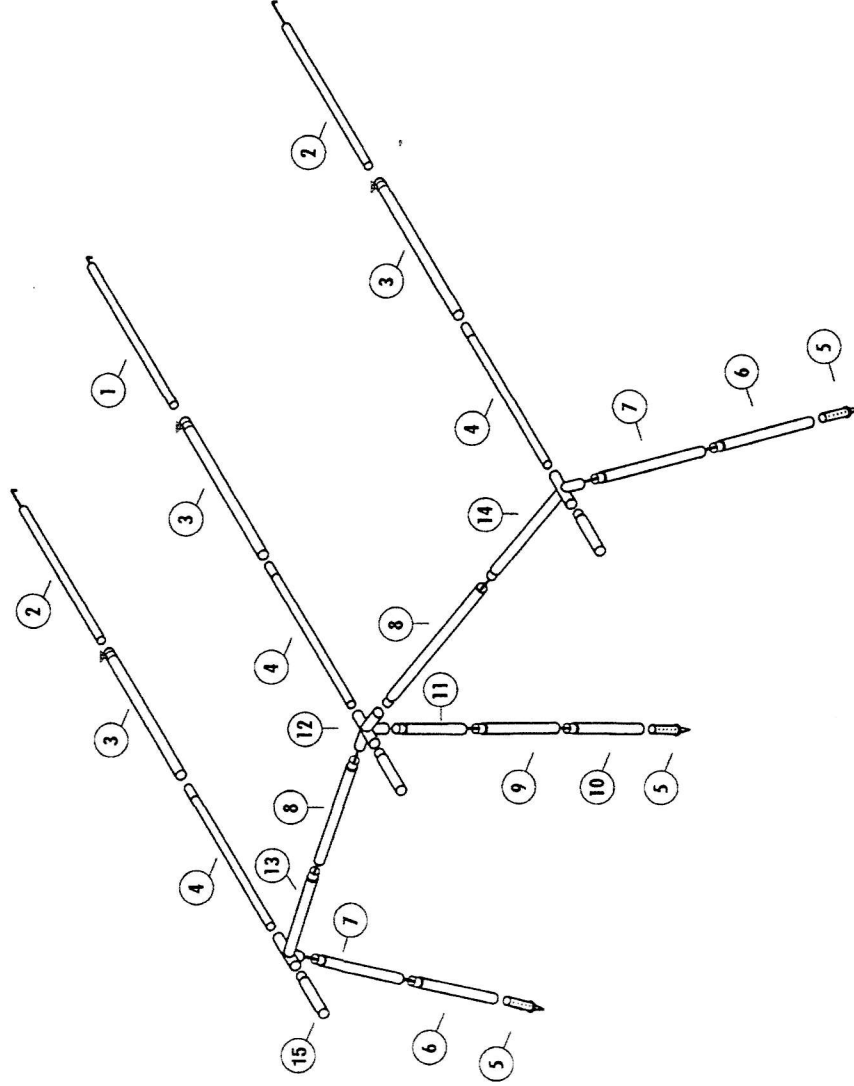



CHALLENGER SUN CANOPY - REF.CL1071

REF NO.	QTY	DESCRIPTION
1	2	ROOF ADJUSTER - LONG HOOK
2	1	ROOF POLE & SPIKE
3	2	ROOF POLE & EYELET
4	1	ROOF ADJUSTER - SHORT HOOK
5	2	LOWER SUPPORT LEG
6	2	ADJUSTABLE FOOT
7	2	SPIKED BRANCH
8	2	CENTRE BRANCH
9	1	APEX ANGLE BRANCH

