

CONWAY TRAILER TENTS

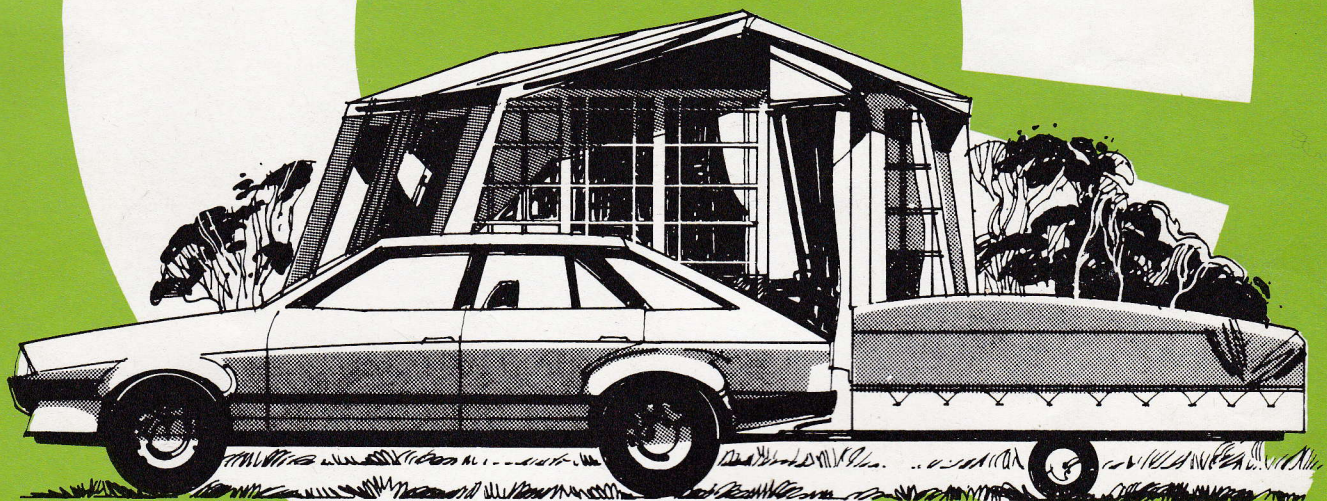

1983

Step-by-step assembly instructions by Photographs.
Hints on assembly and dismantling.

2

All Conway Trailer Tents feature

ASSEMBLY INSTRUCTIONS

MODEL	FOLLOW PAGE NO'S.
Corniche	2,3 6,7
Campa/Campa De Luxe	2,3 4,5
Colt/Colt De Luxe	2,3 8,9
Calypso	10, 11

For all models, apart from the Calypso, follow the instructions illustrated on these pages, then to complete assembly:

for Corniche see pages 6,7
for Campa/Campa De Luxe see pages 4,5
for Colt/Colt De Luxe see pages 8,9

Pages 12-16 show exploded view of trailers and extension frames with list of parts.

These simple instructions show you in easy stages all you need to know on how to assemble your Conway Trailer Tent. Every model shares the same basic assembly system but there are variations in the final stages for each model. When you have completed all the stages shown here, just unfold the relevant pages for your model to finish off.

A Conway Trailer Tent will take you only minutes to erect, and needs the minimum of effort — it really is child's play.

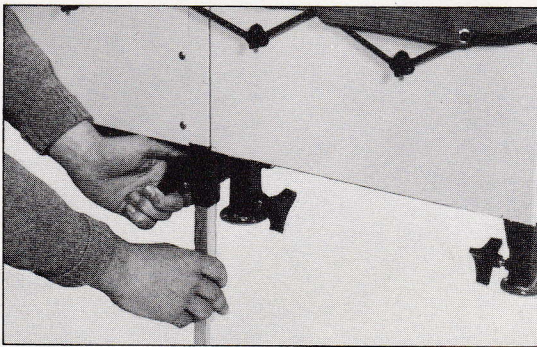

1. Unhitch trailer from car. Position on as level ground as possible. Drop down the four trailer corner jacks.

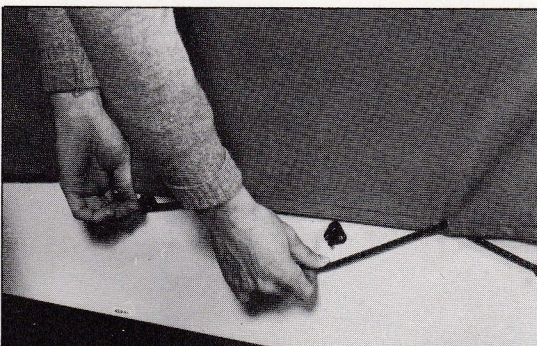

2. Remove cover by detaching elastic cord from black plastic cleats.

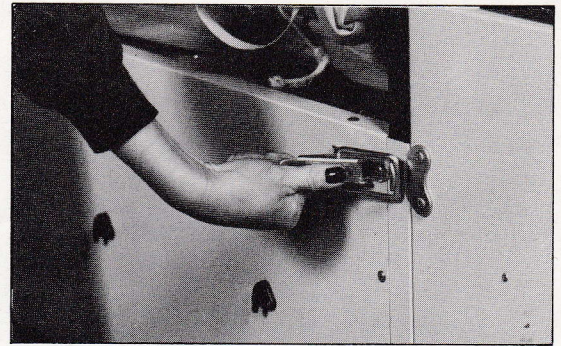

3. Drop the four corner kitchen support jacks to within 1/2 inch of ground. Release the two protex fasteners on either side of the kitchen, which will in turn release the kitchen from trailer.

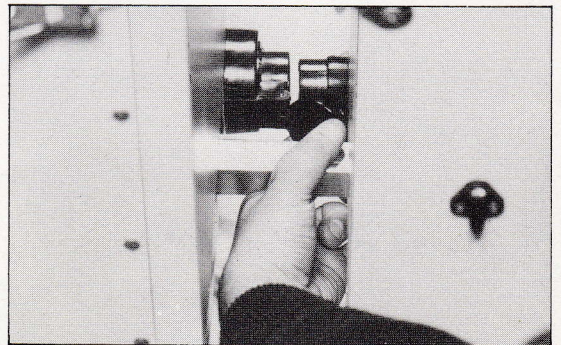

4. Now slide kitchen away enough to disconnect 7 pin plug.

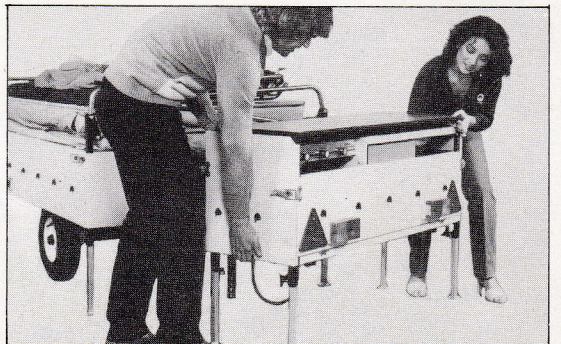

5. Slide the kitchen off carrying rails and away from the trailer.



6. Swing over left hand cabin roof support frames and then same on right hand side.

re a fast simple assembly system

3

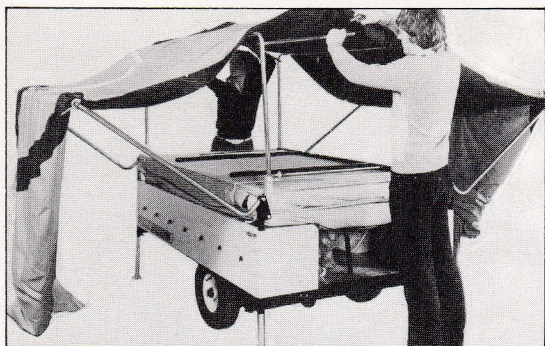

7. Lift up the two hinged arms to form the 5th roof support pole.



11. Clip the inner tents to the framework.



8. Extend each of the 4 cabin support poles by pushing upwards simultaneously at front and back. Locate the small button clip in the centre at the back of 5 holes in each pole. Adjust as necessary when pegging out.



12. Pull down all walls of cabin canvas.

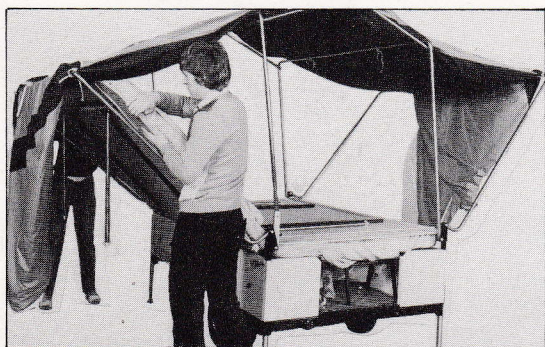

9. Fold over each bed board and mattress to each side. Check that each bed leg is securely located and adjust as necessary.

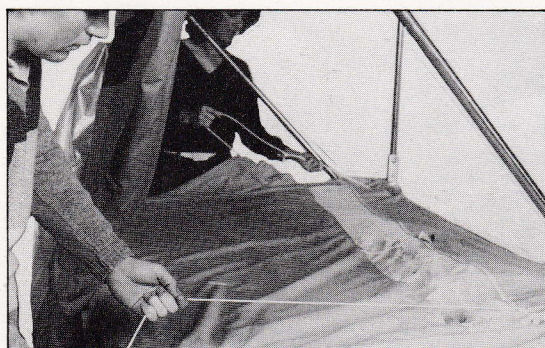
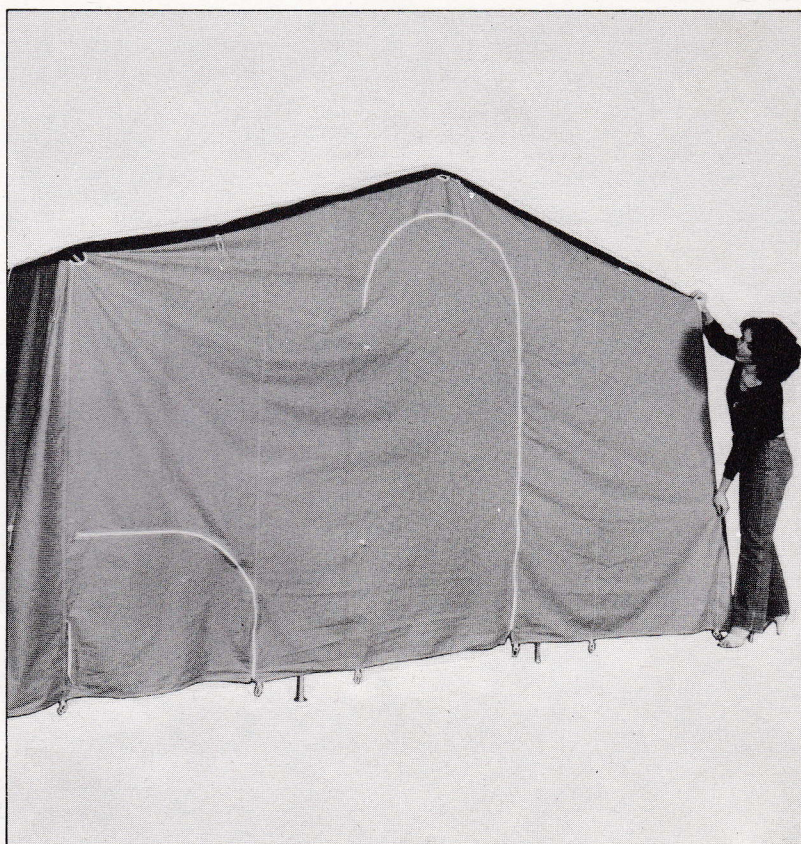

10. Release elastic bands restraining inner tents and mattresses.

4

CONWAY CAMPA AND

An ideal touring trailer tent, the Campa de Luxe has a sleeping section which can be erected in only 4-5 minutes for easy overnight stops. And its canopy and zip-on extension give a huge lounge area so that you can enjoy longer stops in complete comfort.

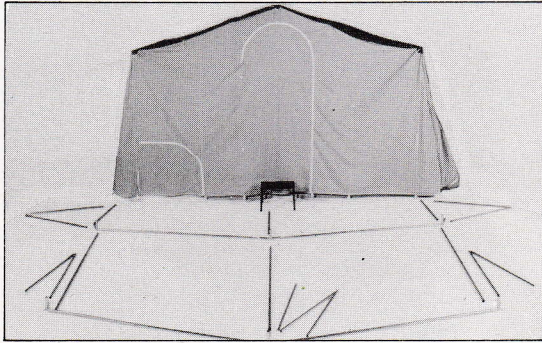

14. Layout structure of framework. See parts list overleaf for detailed diagram.

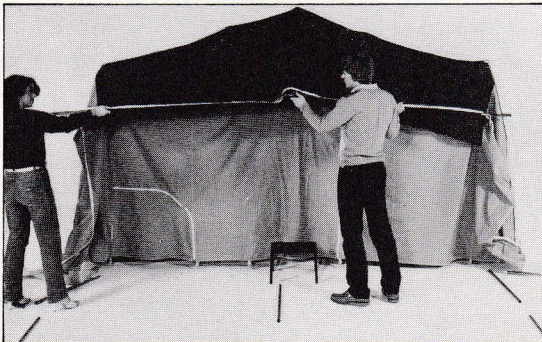

15. Slide front roof awning poles through sleeve.

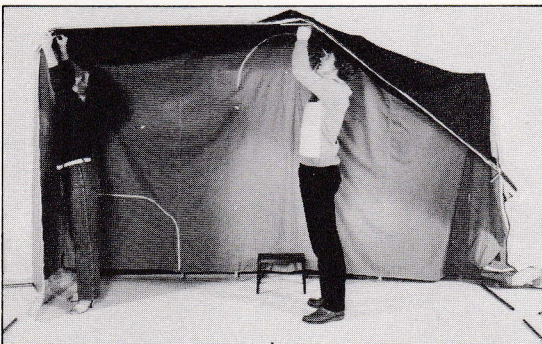

16. Connect three roof support poles to front roof awning poles.

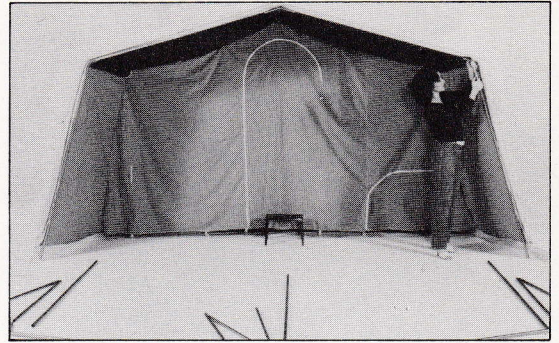

17. Attach outside support legs and then adjust roof support poles.

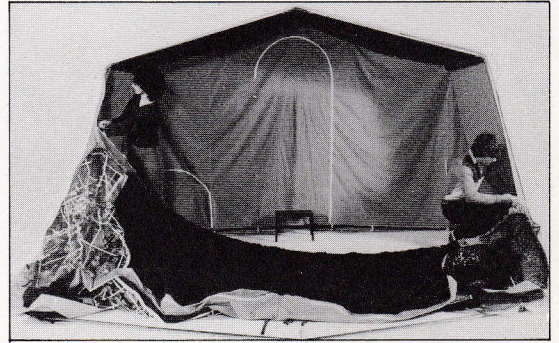

18. Unroll extension canvas on your ground sheet and zip canvas to main tent.

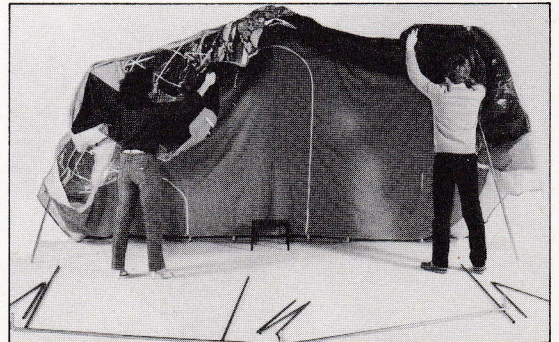

19. Throw extension canvas over roof of main tent.



20. Connect centre cabin roof pole to main tent frame and attach to centre extensions "A frame".

CAMPA DELUXE

5



21. Add side cabin roof poles and legs leaving bottom of front support legs broken.

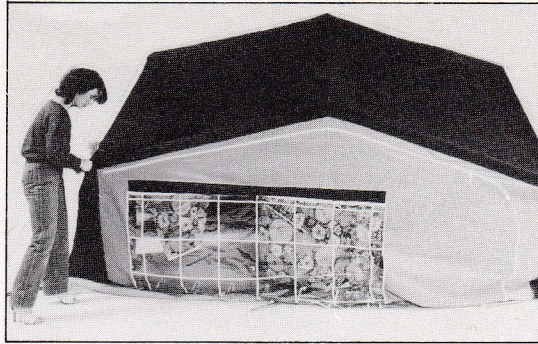

23. Locate over the spikes.

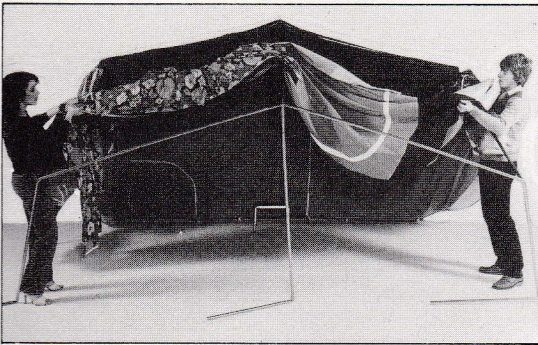

22. Pull extension canvas down over roof support frame.

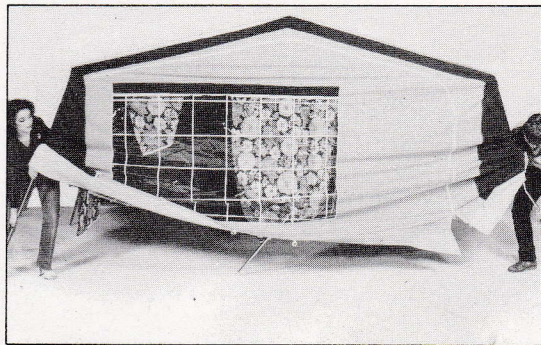

24. Connect front legs and raise extension to full height.

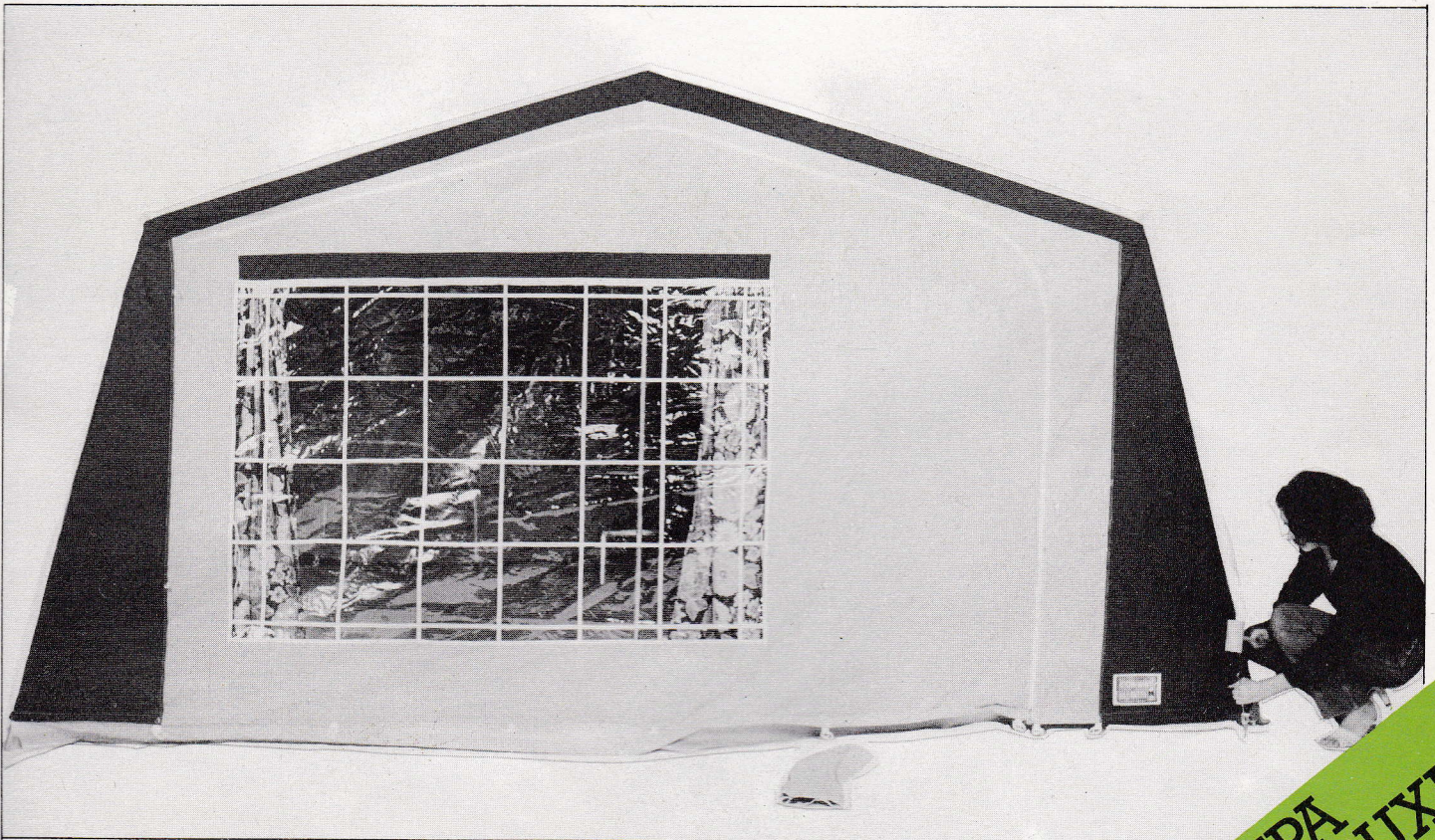

25. Peg out with all zips closed ensuring centre gusset at back is in line with the tow bar.

CAMPA
CAMPA DELUXE



COLT, CAMPA AND CALYPSO TRAILER BODY

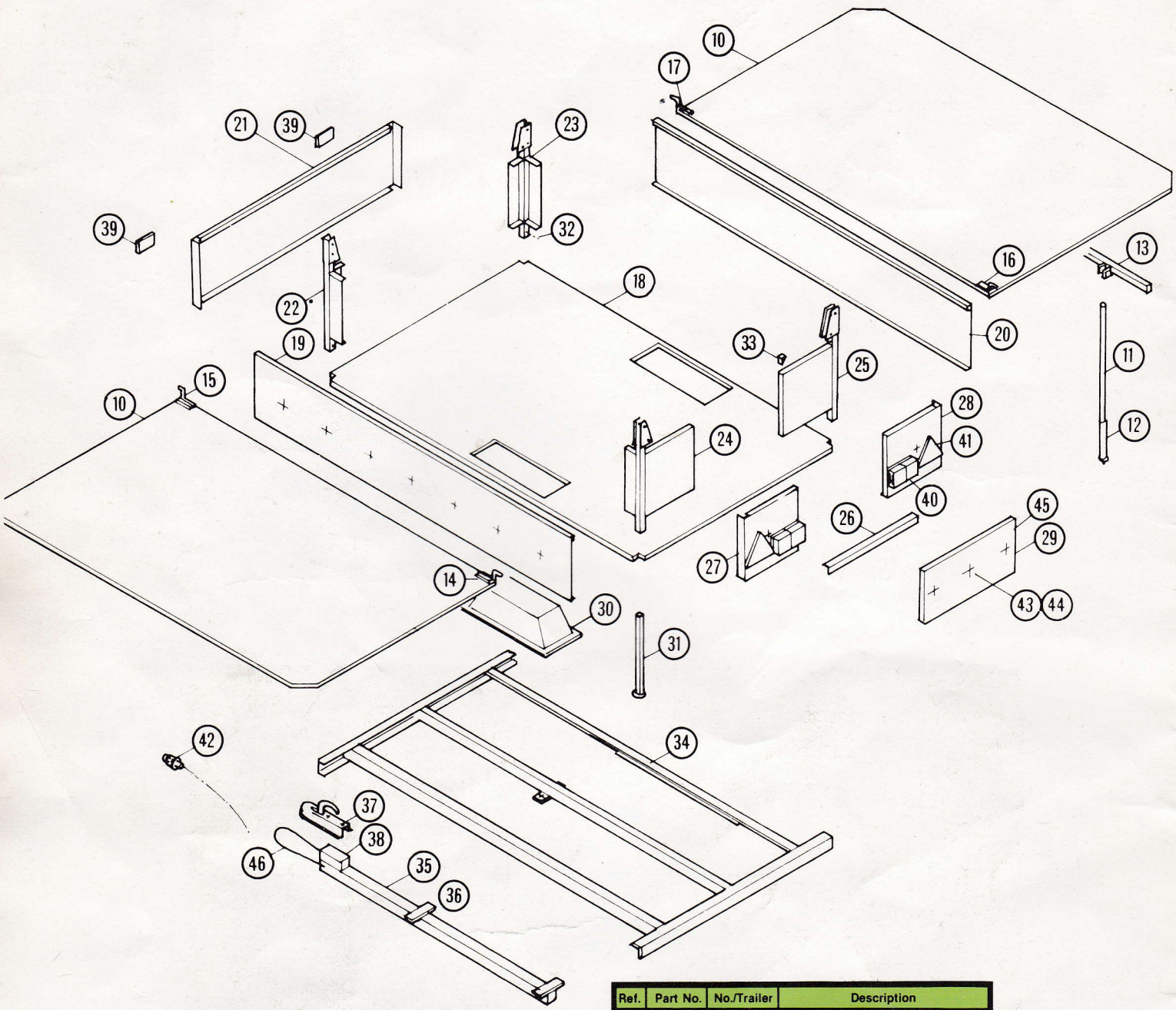

Ref.	Part No.	No./Trailer	Description
10	83165	2	BED BOARD — LH & RH.
11	83141	4	BED SUPPORT LEG — INNER TUBE.
12	83142	4	BED SUPPORT LEG — OUTER TUBE.
13	83148	2	BED STIFFENING ROD WITH HINGE BOLTS AND LOCK NUTS.
14	83156	ONE	LH REAR BED HINGE — LONG CRANK.
15	83157	ONE	LH FRONT BED HINGE — LONG CRANK.
16	83158	ONE	RH REAR BED HINGE — SHORT CRANK.
17	83159	ONE	RH FRONT BED HINGE — SHORT CRANK.
18	83699	ONE	TRAILER BASEBOARD.
19	83811	ONE	SIDE PANEL — LH.
20	83811	ONE	SIDE PANEL — RH.
21	83812	ONE	FRONT PANEL.
22	83705	ONE	CORNER PIECE — LH FRONT.
23	83706	ONE	CORNER PIECE — RH FRONT.
24	83707	ONE	CORNER PIECE — LH REAR.
25	83708	ONE	CORNER PIECE — RH REAR.
26	83718	ONE	KICKING STRIP.
27	83719	ONE	CLADDING FOR LH REAR PANEL COMPLETE WITH LIGHTS, ETC.

Ref.	Part No.	No./Trailer	Description
28	83720	ONE	CLADDING FOR RH REAR PANEL COMPLETE WITH LIGHTS, ETC.
29	83721	ONE	REAR DOOR COMPLETE.
30	83722	2	WHEEL ARCH.
31	83179	4	SUPPORT LEG JACK.
32	83180	4	SUPPORT LEG JACK LOCKING SCREW.
33	83723	2	CORNER PIECE FOR REAR PANEL.
34	83810	ONE	CHASSIS.
35	83800	ONE	TOWBAR (SEE MAINTENANCE MANUAL).
36		4	TOWBAR LOCKNUT.
37	83637	ONE	50mm COUPLING (FOR BRAKED TRAILER — SEE MAINTENANCE MANUAL).
38	83184	2	COUPLING BOLT & LOCKNUT.
39	83226	2	FRONT WHITE REFLECTOR.
40	83221	2	REAR ROAD LIGHT.
41	83223	2	REAR RED REFLECTOR.
42	83222	ONE	SEVEN PIN PLUG.
43	83224		COVER ANCHORAGE BUTTON — TRIANGULAR TYPE.
44	83228		COVER ANCHORAGE BUTTON — CIRCULAR TYPE.
45	83225		PROTEX FASTENER.
46			SAFETY CABLE & U BOLT.
190	83613		BACKREST (OPTIONAL).

CAMPA DE LUXE AND CORNICHE TRAILER BODY

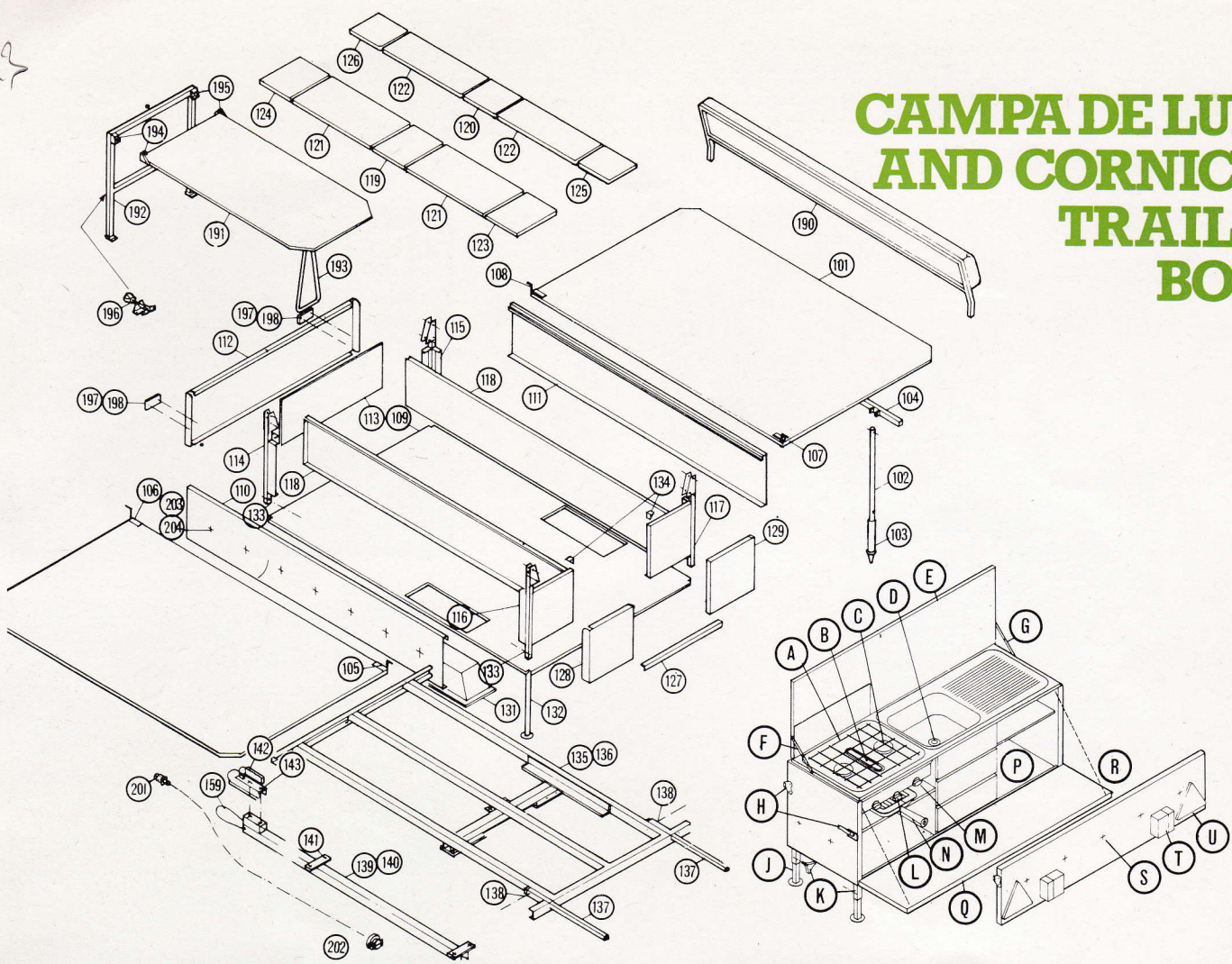

Ref.	Part No.	No./Trailer	Description
101	83165		BED BOARD — LH & RH.
102	83141	2	BED SUPPORT LEG — INNER TUBE.
103	83142	2	BED SUPPORT LEG — OUTER TUBE.
104	83148	2	BED STIFFENING ROD WITH HINGE BOLTS AND LOCK NUTS.
105	83156	ONE	LH REAR BED HINGE — LONG CRANK.
106	83157	ONE	LH FRONT BED HINGE — LONG CRANK.
107	83158	ONE	RH REAR BED HINGE — SHORT CRANK.
108	83159	ONE	RH FRONT BED HINGE — SHORT CRANK.
109	83700	ONE	TRAILER BASEBOARD.
110	83701	ONE	TRAILER SIDE PANEL — LH.
111	83702	ONE	TRAILER SIDE PANEL — RH.
112	83703	ONE	TRAILER FRONT PANEL.
113	83704	ONE	INSIDE FACING FOR FRONT PANEL.
114	83705	ONE	CORNER PIECE — LH FRONT.
115	83706	ONE	CORNER PIECE — RH FRONT.
116	83707	ONE	CORNER PIECE WITH PANEL — LH REAR.
117	83708	ONE	CORNER PIECE WITH PANEL — RH REAR.
118	83709	2	CUPBOARD INSIDE PANEL — LH & RH.
119	83733	ONE	CUPBOARD CENTRE PIECE — LH.
120	83734	ONE	CUPBOARD CENTRE PIECE — RH.
121	83727	2	CUPBOARD DOOR — LH.
122	83728	2	CUPBOARD DOOR — RH.
123	83729	ONE	CUPBOARD END PIECE — LH REAR.
124	83730	ONE	CUPBOARD END PIECE — LH FRONT.
125	83731	ONE	CUPBOARD END PIECE — RH REAR.
126	83732	ONE	CUPBOARD END PIECE — RH FRONT.
127	83718	ONE	KICKING STRIP.
128	83719	ONE	CLADDING FOR LH REAR PANEL.
129	83720	ONE	CLADDING FOR RH REAR PANEL.
131	83722	2	WHEEL ARCH. LH & RH.
132	83179	4	TRAILER SUPPORT LEG JACK.
133	83180	4	TRAILER SUPPORT LEG JACK LOCKING SCREW.
134	83723	2	CORNER PIECE FOR REAR PANEL.
136	83751	1	CHASSIS.
137	83752	2	KITCHEN CARRYING RAIL.
138	83180	2	KITCHEN CARRYING RAIL LOCKING SCREW.
140	83753	1	TOWBAR — SEE MAINTENANCE MANUAL.

Ref.	Part No.	No./Trailer	Description
141		4	TOWBAR LOCKNUTS.
142	83183	ONE	50mm COUPLING — NONE BRAKED TRAILER.
143	83184	2	COUPLING BOLT & LOCK NUT.
191	83150		TABLE.
192	83151	ONE TABLE	TABLE SUPPORT FRAME.
193	83152	ONE TABLE	TABLE HINGED LEG.
194	83153	ONE TABLE	TABLE LOCATING BRACKET — LH.
195	83154	ONE TABLE	TABLE LOCATING BRACKET — RH.
196	83155	2 TABLE	TABLE LOCKING BRACKET WITH SCREW.
198	83226	2	FRONT WHITE REFLECTOR.
201	83222	1-TRAILER	SEVEN PIN PLUG.
202	83227		SOCKET FOR SERVICE PIN PLUG.
203	83224		COVER ANCHORAGE BUTTON — TRIANGULAR TYPE.
204	83228		COVER ANCHORAGE BUTTON — CIRCULAR TYPE.
205	83225		PROTEX FASTENER.

Spares for kitchen

Ref.	Part No.	No./Kitchen	Description
A	83542	ONE	COOKER TOP GRID
B	83541A	ONE	CENTRE GRILL
C	83541B	2	SIDE BURNER
D	83212	ONE	SINK WASTE AND PLUG
E	83546	ONE	KITCHEN TOP
F	83203	ONE	LH KITCHEN TOP STAY
G	83202	ONE	RH KITCHEN TOP STAY
H	83225	4	PROTEX FASTENER
J	83179	4	SUPPORT LEG JACK
K	83180	4	LOCKING SCREW
L	83541C	ONE	GRILL CONTROL KNOB
M	83541D	2	SIDE BURNER CONTROL KNOB
N	83543	ONE	GRILL PAN AND WIRE
P	83545	2	DRAWER
Q	83537-8	ONE	REAR FLAP
R		2	SUPPORT CHAIN 28" LONG
S	83228	9	COVER ANCHORAGE BUTTON
T	83583	2	REAR LIGHT
U	83582	2	REFLECTOR
V	83736	2	HINGE FOR KITCHEN TOP
W	83363	2	HINGE FOR REAR FLAP

CABIN FRAME FOR ALL MODELS

Colt, Campa and Campa De Luxe Trailer Tents

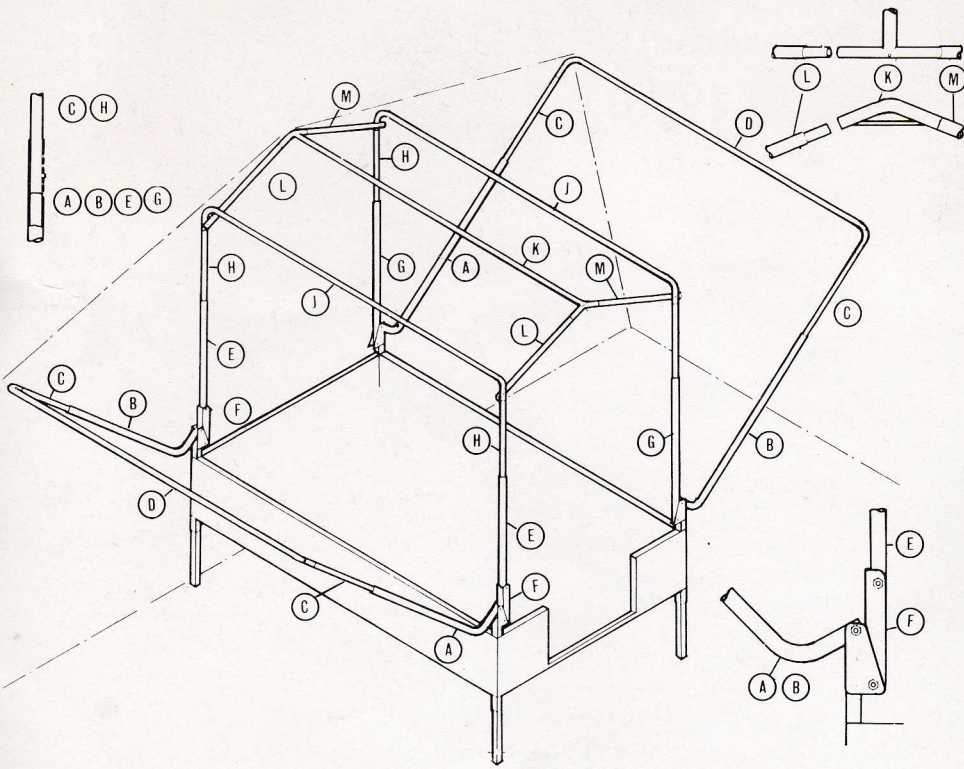

Ref.	Part No.	No./Trailer	Description
A	83813	2	LOWER CABIN POLE. LH REAR & RH FRONT.
B	83814	2	LOWER CABIN POLE. LH FRONT & RH REAR.
C	83815	4	UPPER CABIN POLE. LH & RH.
D	83816	2	CABIN ROOF POLE. LH & RH.
E	83817	2	LOWER CENTRAL CABIN POLE. LH REAR & LH FRONT.
F	83346	2	HINGE FRAME BRACKET.
G	83818	2	LOWER CENTRAL CABIN POLE. RH REAR & RH FRONT.
H	83819	4	UPPER CENTRAL CABIN POLE. LH & RH REAR & FRONT.
J	83820	2	CENTRAL CABIN ROOF POLE LH & RH.
K	83821	ONE	CABIN RIDGE POLE.
L	83822	2	RIDGE POLE TIE PIECE WITH BUTTON CLIP — LH.
M	83823	2	RIDGE POLE TIE PIECE WITHOUT BUTTON CLIP — RH.

Corniche Trailer Tents

Ref.	Part No.	No./Trailer	Description
A	83335	2	LOWER CABIN POLE. LH REAR & RH FRONT.
B	83336	2	LOWER CABIN POLE. LH FRONT & RH REAR.
C	83337	4	UPPER CABIN POLE. LH & RH.
D	83338	2	CABIN ROOF POLE. LH & RH.
E	83339	2	LOWER CENTRAL CABIN POLE. LH REAR & LH FRONT.
F	83346	2	HINGE FRAME BRACKET.
G	83340	2	LOWER CENTRAL CABIN POLE. RH REAR & RH FRONT.
H	83341	4	UPPER CENTRAL CABIN POLE. LH & RH REAR & FRONT.
J	83342	2	CENTRAL CABIN ROOF POLE. LH & RH.
K	83343	ONE	CABIN RIDGE POLE.
L	83344	2	RIDGE POLE TIE PIECE WITH BUTTON CLIP — LH.
M	83345	2	RIDGE POLE TIE PIECE WITHOUT BUTTON CLIP — RH.

CORNICHE EXTENSION FRAME

List of parts for extension and sun canopy frames

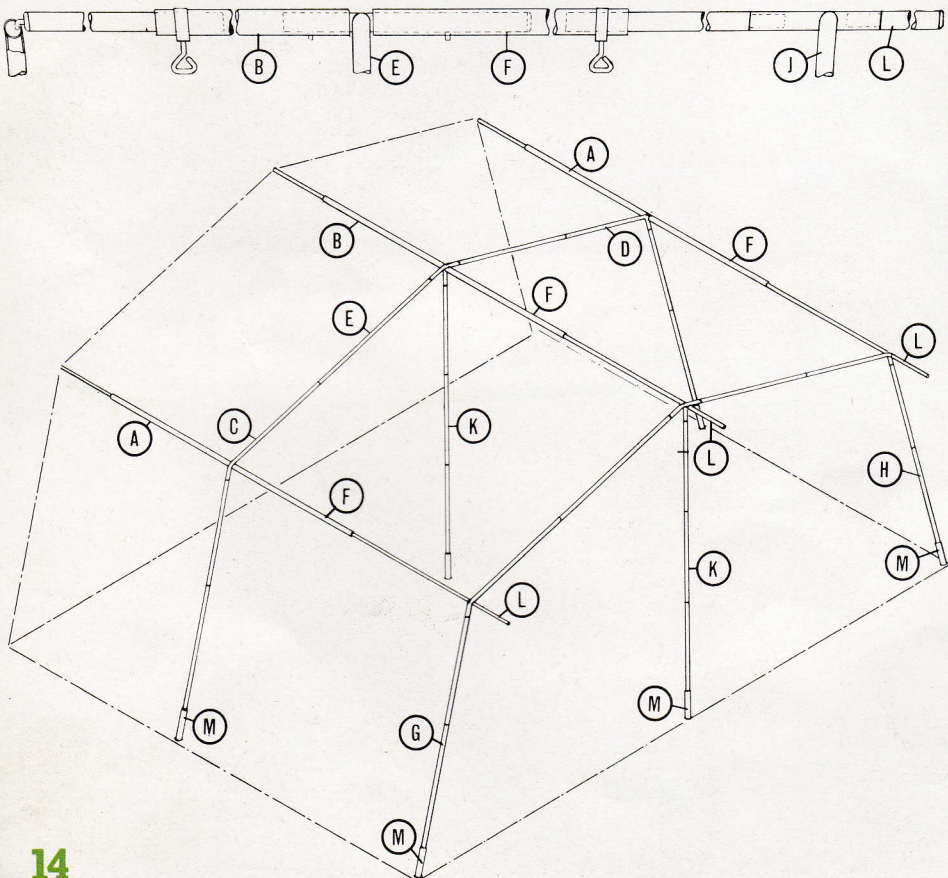

Ref.	Part No.	No./Trailer	Section	Description
A	83910-12	2	1.4m	LH & RH ROOF POLE (WITH LONG HOOK)
B	83911-12	ONE	1.4m	CENTRE ROOF POLE (WITH SHORT HOOK)
C	83913-16	ONE	1.4m	LH BRANCH WITH LEG
D	83913-15	ONE	1.4m	RH BRANCH WITH LEG
E	83917-18	ONE	1.4m	CENTRE BRANCH
F	83922-23	3	2m	ROOF POLE
G	83973-26	ONE	2m	LH BRANCH WITH LEG
H	83913-25	ONE	2m	RH BRANCH WITH LEG
J	83917-24	ONE	2m	CENTRE BRANCH
K	83919-21	2	BOTH	CENTRE LEG
L	83927	3	2m	ROOF EXTENSION POLE
M	83142	6	BOTH	ADJUSTING FOOT

CAMPA, CAMPA DE LUXE EXTENSION FRAME

List of parts for canopy and extension frames

15

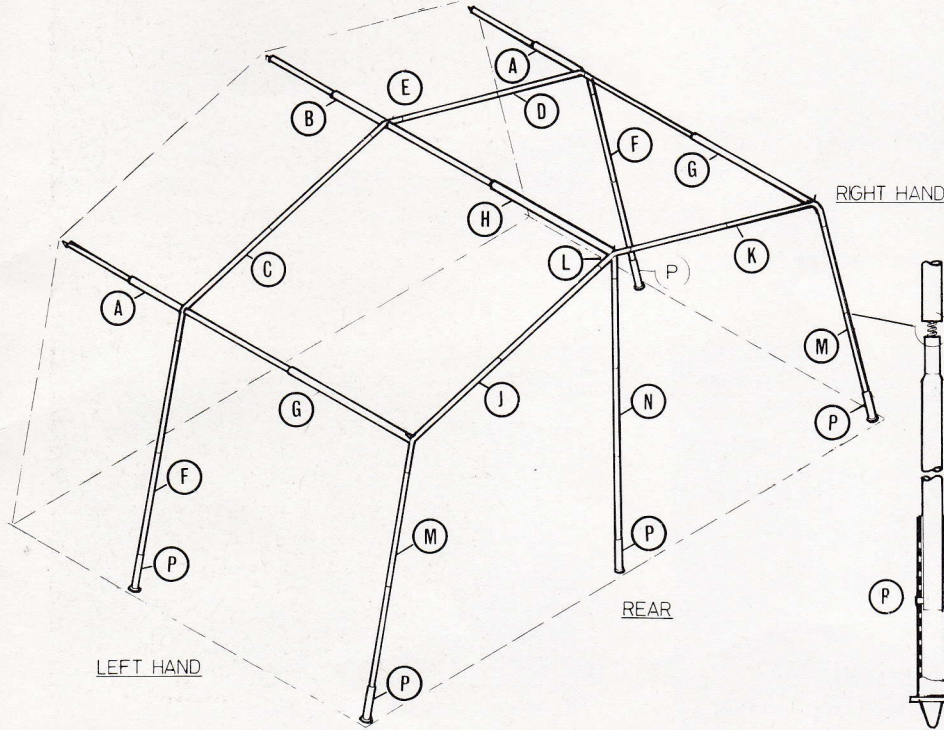
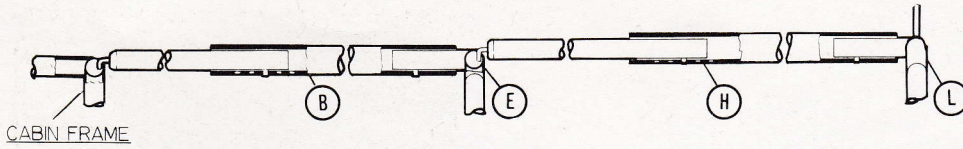

Ref.	Part No.	No./Trailer	Section	Description
A	83871-73	2	CANOPY	LH & RH ROOF POLE (WITH LONG HOOK).
B	83872-73	ONE	CANOPY	CENTRE ROOF POLE (WITH SHORT HOOK).
C	83876-78	ONE	CANOPY	LH BRANCH WITH STRAIGHT POLE.
D	83877-78	ONE	CANOPY	RH BRANCH WITH STRAIGHT POLE.
E	83879	ONE	CANOPY	CENTRE BRANCH.
F	83874-75	2	CANOPY	LH & RH SUPPORT LEG.
G	83880-82	2	EXTENSION	LH & RH ROOF POLE (WITH SHORT HOOK).
H	83881-82	ONE	EXTENSION	CENTRE ROOF POLE (WITH SHORT HOOK).
J	83883-85	ONE	EXTENSION	LH BRANCH WITH STRAIGHT POLE.
K	83884-85	ONE	EXTENSION	RH BRANCH WITH STRAIGHT POLE.
L	83886	ONE	EXTENSION	CENTRE BRANCH.
M	83874-75	2	EXTENSION	LH & RH SUPPORT LEG.
N	83887-89	ONE	EXTENSION	CENTRE SUPPORT LEG.
P	83142	5	CAN/EXT.	ADJUSTING FOOT.

COLT EXTENSION FRAME

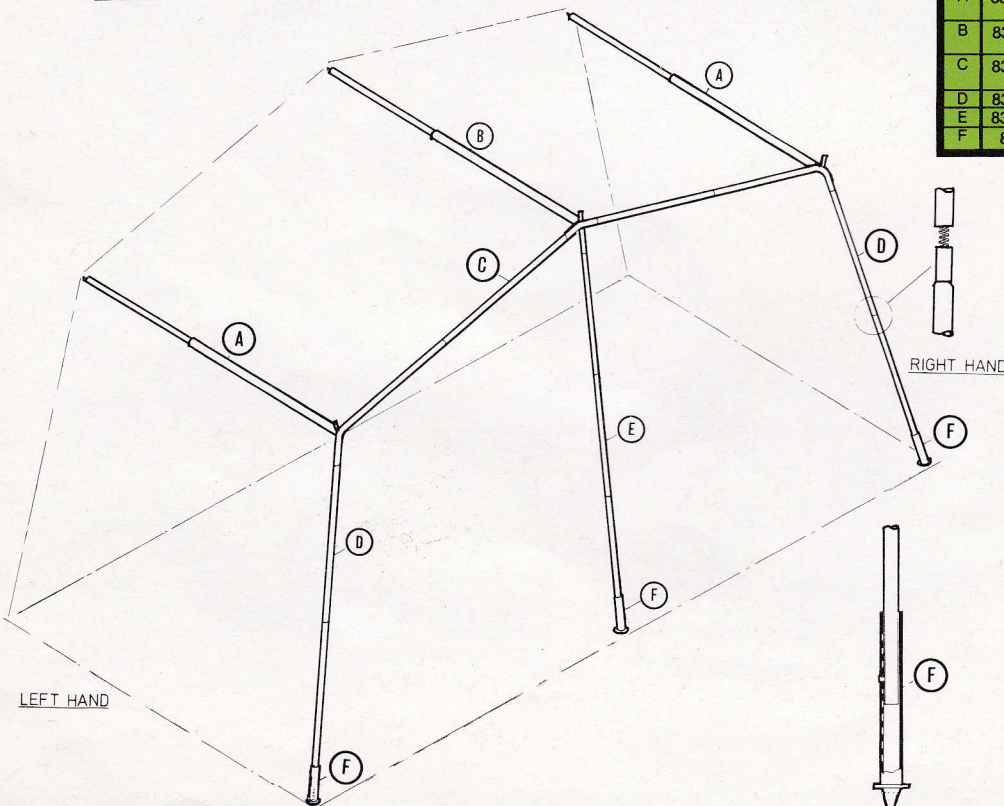
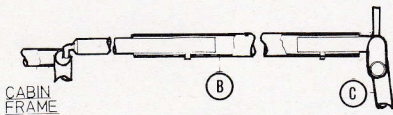

Colt Trailer Tent

Ref.	Part No.	No./Trailer	Description
A	83858-60	2	LH & RH ROOF POLE WITH LONG HOOK.
B	83859-60	ONE	CENTRE ROOF POLE WITH SHORT HOOK.
C	83863-66	ONE	ROOF SPAN WITH LH, RH & CENTRE BRANCHES.
D	83861-62	2	LH & RH SUPPORT LEG.
E	83867-69	ONE	CENTRE SUPPORT LEG.
F	83142	3	ADJUSTING FOOT.