

CRUSADER INSTRUCTIONS

CRUSADER ERECTING INSTRUCTIONS

The following instructions are intended as a step-by-step guide to help you erect your Conway Unit. Please read your Owners Manual thoroughly where you will find other helpful information within the section on Pitching.

Main cabin see cruiser	1-9
Toilet comp - Crusader	10-15
Kitchen	16-19
Awning erection see Cruiser	10-15
Dual sun canopy erection see Cruiser	13-20
Cabin frame drawing	
Awning	
Dual sun canopy frame drawing	

Important:

Attempting to fit/remove the bed support legs in the extended position will result in bent bed sliders causing difficulty in opening/closing the beds. Ensuring that the bedboards are held in the fully extended position will help you fit the bed support legs correctly. The 4 bed stop pins provided fit into holes in the top of the aluminium bed tracks to prevent the beds sliding inwards.

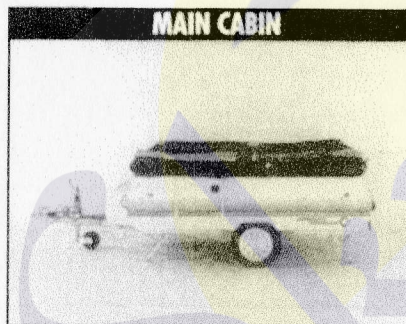

1. Remove trailer from car, fully apply handbrake to vertical position and level trailer using jockey wheel. Remove waterproof cover and wind down 4 corner steadies.



3. Open both canvas and trailer doors and fold back (See special notes)

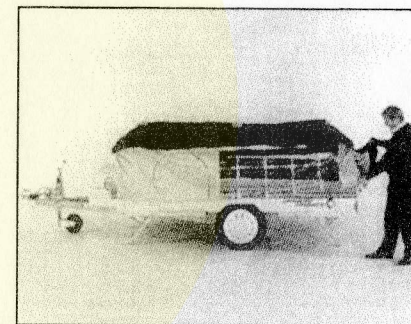

2. Pull down folded sides of canvas and loosen canvas tucked into ends.



4. Starting at the back of the trailer, lift up the top cross frame and work up and down a few times. This allows air to get under the canvas enabling smooth slide out of the bed frames.

CRUSADER ERECTING INSTRUCTIONS CONTINUED TOILET COMPARTMENT 2002 ONWARDS

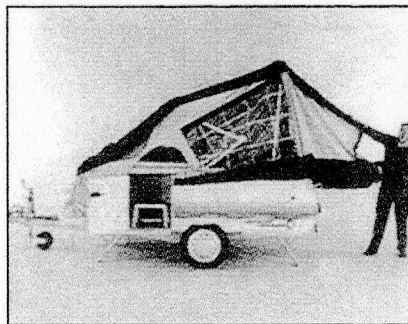

5. Still holding up the cross frame, pull steadily on the bed handle, slide bed out fully until it hits the end stops, the frame will automatically raise the cabin canvas, have someone hold this bed out or fit one of the bed stop pins via the window side zip to prevent the bed sliding in as you proceed. The bed stop pins fit into holes in the top of the aluminium bed slide track.

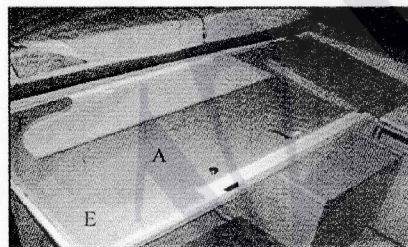

8. The toilet compartment has 3 separate HINGED panels.
1. (A) Door & frame inc. (E) Right-hand and (F) Left-hand hinged roof supports, and strap*
2. (B) Right hand wall and strap*
3. (C) Left-hand DOUBLE HINGED wall including sink and (D) mirror panel. *Straps are press-stud to assist erection/folding of toilet compartment. Straps are fitted to cabin frame.

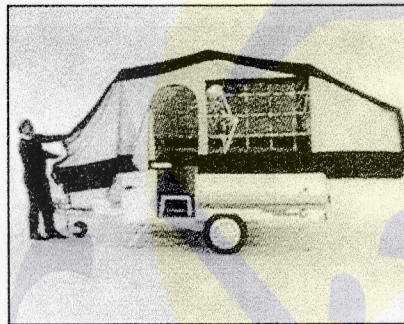

6. Repeat the operation for the front bed. Fitting a second bed stop pin via the open door. ENSURE that both beds are in the fully extended position before attempting to fit the bed support legs.



9. Enter trailer by lifting and supporting the hinged door and frame panel (A).
Fit press-stud strap to left-hand edge to hold upright. The internal toilet door catch should be in 'locked' position when lifting, to help hold the door shut.

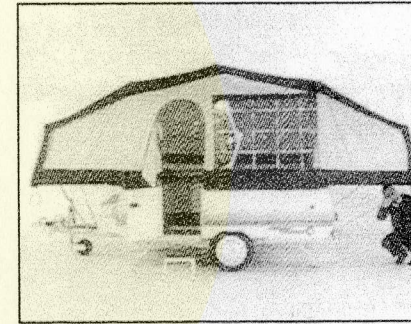

7. ENSURE that the bed support legs are in the fully retracted position. Fit to chassis first and then to brackets on underside of bedboard, giving support to bedboard without forcing upwards. Extend the bed support legs out to button clip only when both legs are fitted. Secure the bed end canvas by fitting shock cord to cleats under bedboard

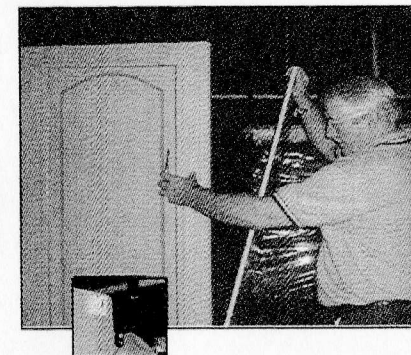

10. Ensuring that (A) is clear of (B) at the hinge point. Lift hinged right-hand wall panel (B) until VERTICAL - fit press-stud strap to OUTER edge. 'Unlock' the door BEFORE gently joining (A) to (B), checking visually that the internal plastic catch is lined up to secure both.

CRUSADER TOILET COMPARTMENT ERECTING INSTRUCTIONS - 1999 ONWARDS

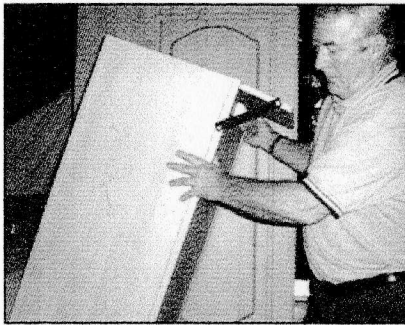

11. Ensure the front bedboard is fully extended then lift the hinged wardrobe and slide into position. Fold back the top flap and screw in the interior handwheel to secure.



14. Holding the mirror panel (D) horizontal, first lift the hinged left-hand roof support (F) to its full height, and then follow with the mirror panel until VERTICAL. Clip (F) and (D) together to secure. Folding is a reversal of this procedure.



12. Open the toilet door and lift the hinged right-hand roof support (E) pushing the wall (B) out slightly, allowing E & B to clip together to secure.

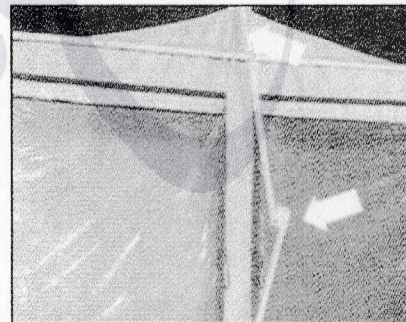

15. Step inside trailer making sure the centre roof ridge pole is central on double roof canvas strips then straighten ridge frame upright by closing the bracket.



13. Lift the left-hand walls (C) & (D) until the sink panel (C) ONLY is vertical and can be held in position by adjustment BEHIND the 'stop-block' fitted to the door panel (A) as you step inside the toilet compartment. NOTE HOW PANEL (D) IS STORED WHEN FOLDED TO ALLOW EXTRA STORAGE SPACE.



16. Extend bed end frames at each end and adjust with button clips as necessary to tension body canvas. NOTE: 1st button for retention when in transit. 2nd button for adjustment when erecting. ENSURE the remaining 2/4 bed pins are now fitted to prevent the beds sliding in.

CRUSADER KITCHEN ASSEMBLY

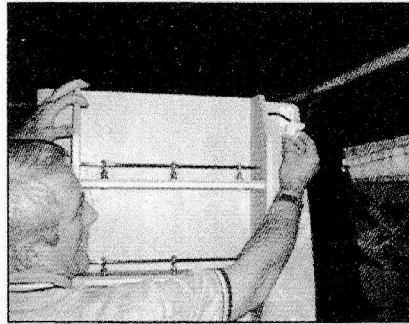

17. Fit the side shelf to the toilet wall, and plug in to 12v socket.

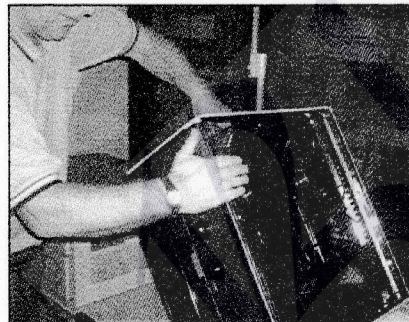

19. Lift over the hinged "Spinflow" cooker unit (supporting the glass lid when setting up or folding down). The gas supply pipe to the hob and oven units is pre-fitted and gas supply is via the manifold tap in the offside day seat locker.

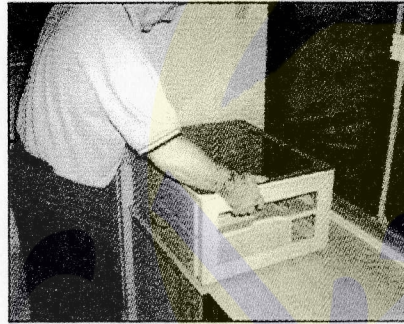

18. Lift the sink unit into position first next to the toilet wall and ensure that (at the rear of the sink) the waste hose, hot & cold water pipes (push fit) and the earth lead are all located/connected correctly. Twist the water faucet into position and open the cold tap to vent the system for use or when winter draining.

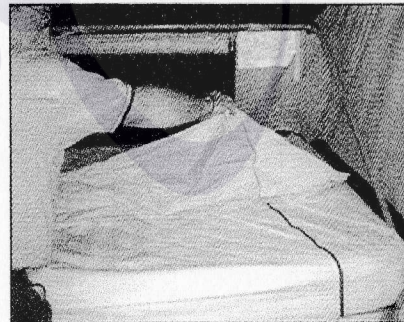

20. Roll up the nylon "Dry-Pack" mattress covers to the outer edge of the bed. To prevent condensation - do not use under mattresses. Fit inner tents around mattresses - NOTE: front and rear are handed and clip to cabin frame.

Special Note:

Ensure that all cabin frame sections are in their lowest position and that the upright brackets are in the 'OPEN' position before closing the trailer.

Always site the trailer on as level ground as possible. Where necessary use the jockey wheel to level the trailer. The four corner steadies should NOT be used to level the trailer.

Both the canvas and the trailer doors should be OPEN when erecting, and CLOSED when folding the trailer.

Remove the roof lining and curtains before closing the trailer.

Unclip inner tents and fold neatly on mattresses.

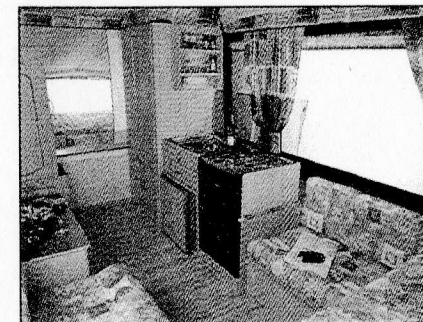

21. Fit 'expandable' curtain wires through top of curtains and clip to ends of horizontal tie bars on cabin frame. Intermediate plastic hooks will help support curtains. Arrange dinette cushions, clip up roof liner.

CRUSADER CABIN FRAME-PARTS

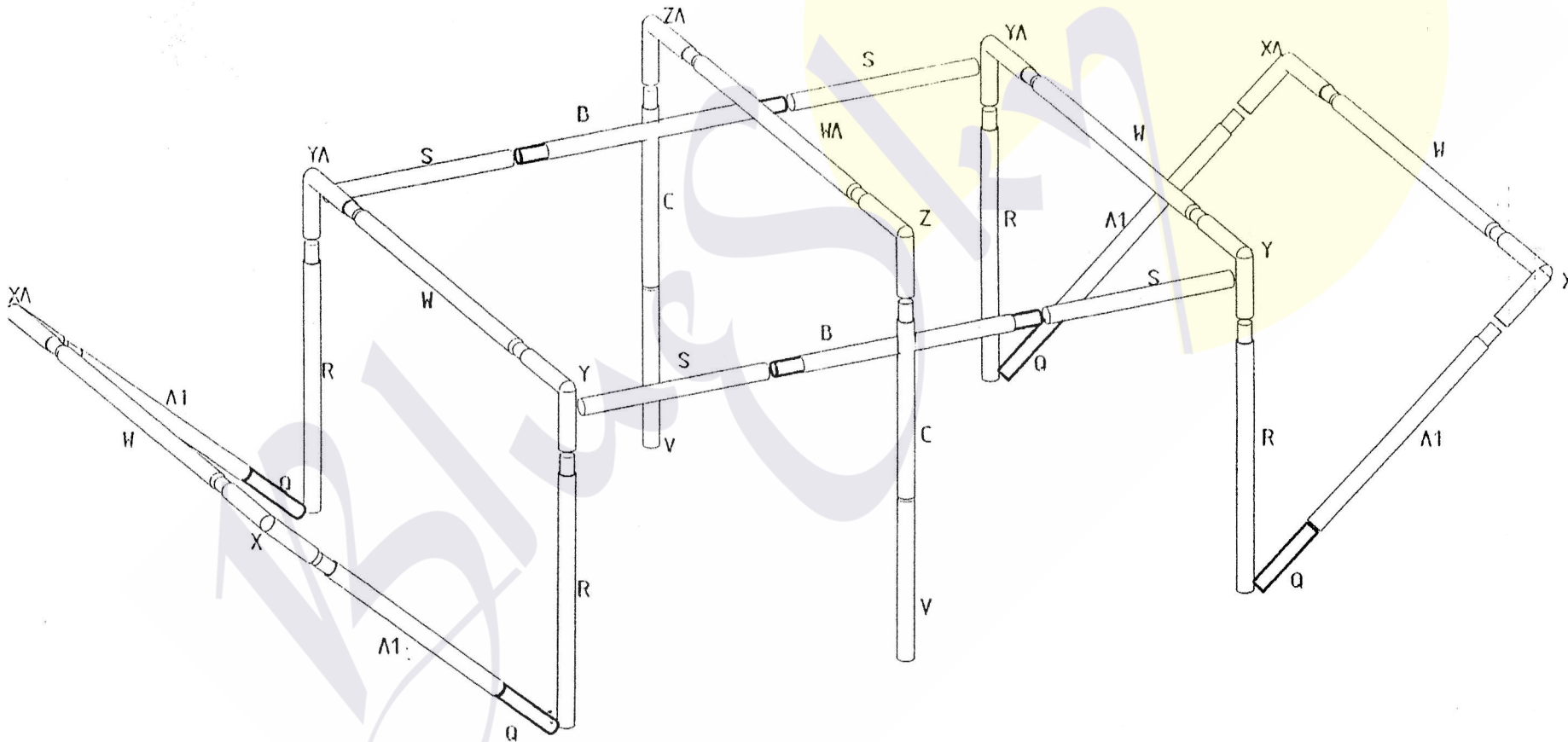

CRUSADER AWNING FRAME-PARTS

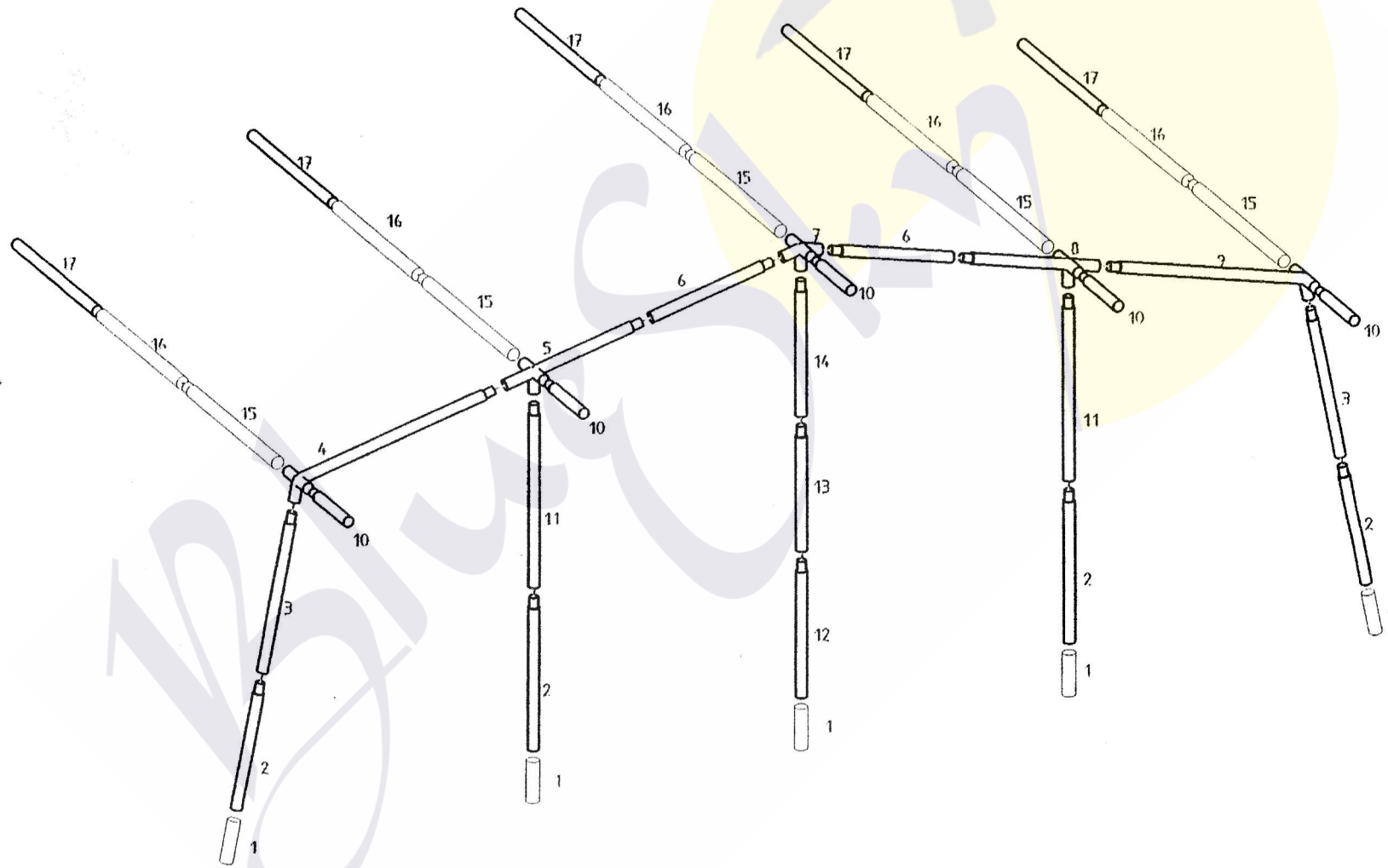

DUAL SUN CANOPY FRAME-PARTS CRUSADER

NOTE: Poles (Nº 15) are 'Hook' poles for fitting to cabin. Poles (Nº 16) are 'Clip-On' poles for fitting to front of awning.

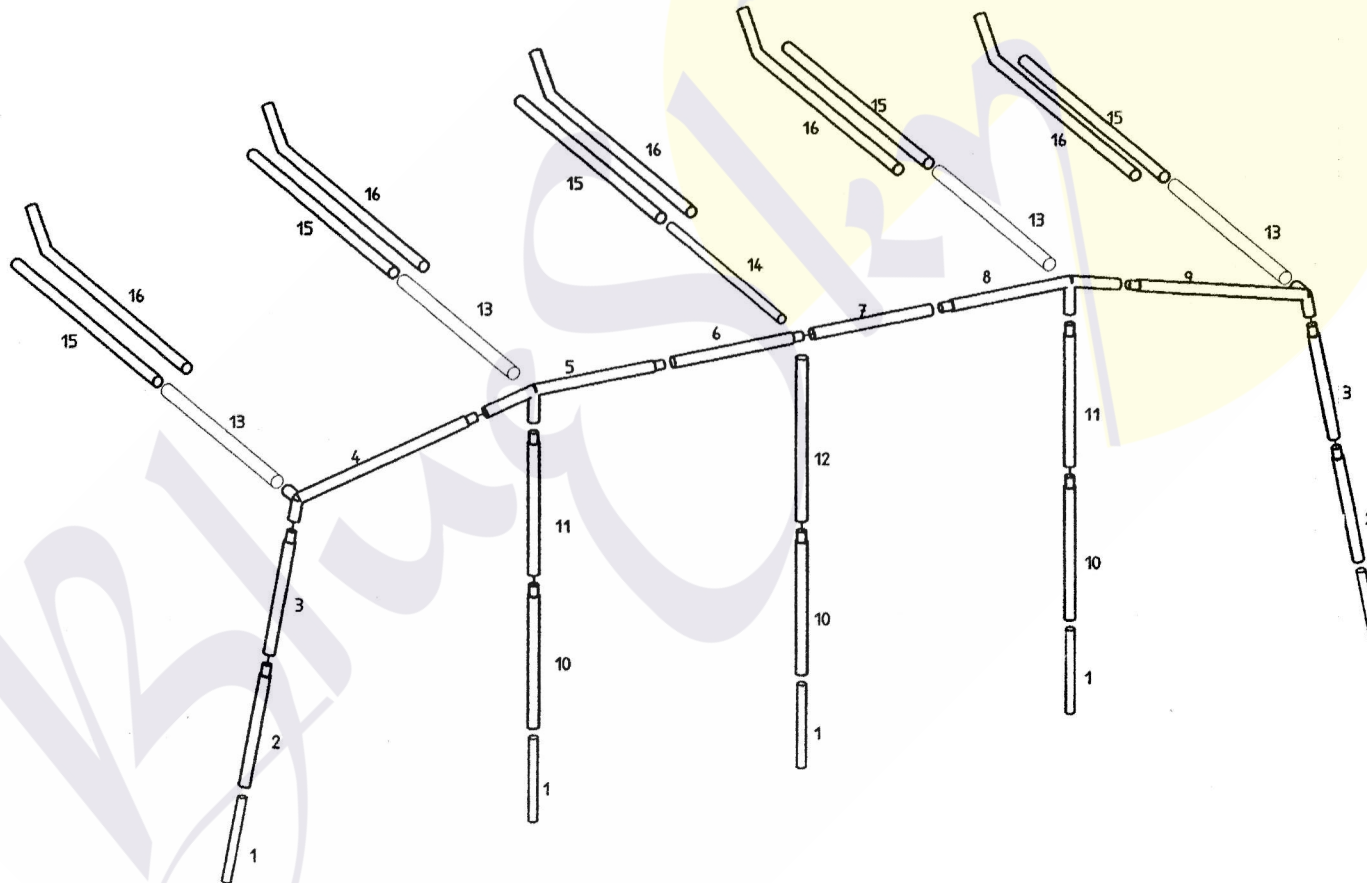

2002 SUGGESTED PACKING PLAN

SUGGESTED PACKING PLAN e.g. Crusader.

NOTE: Heavy items placed when/where possible over or to rear of axle. Certain items shown are optional.



SIDE SHELF

HINGED COOKER UNIT

TABLE

AWNING CANVAS & FRAME

ROOF SHELF

SINK UNIT

WARDROBE

TOILET COMPARTMENT WALLS
(A, B, C & D)