



## CONWAY TRAILER TENTS CABIN ERECTING INSTRUCTIONS - ALL MODELS

The following instructions are intended as a step-by-step guide to help you erect your Conway Unit. Please read your Owners Manual thoroughly where you will find other helpful information within the section on Pitching.

All Models

1-9



**1.** Position trailer on as level ground as possible. Release the four corner steadies and adjust as necessary. Use the four plywood pads provided.

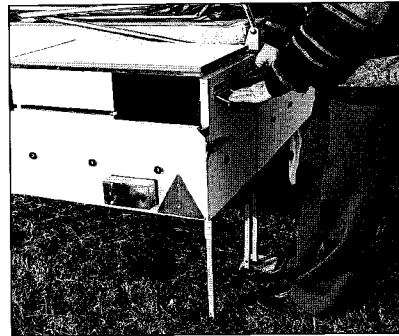

**2.** Unclip and remove the cover.  
DE-LUXE MODELS: Unfasten and remove the kitchen unit. Do not forget to unclip the seven pin plug under the kitchen.

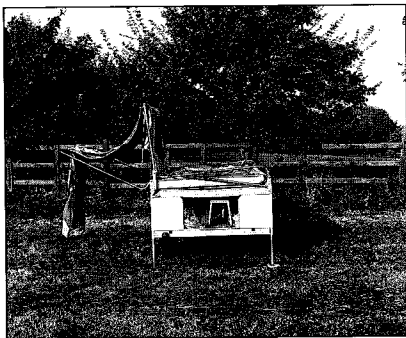

**3.** Swing over the near side roof support frames.

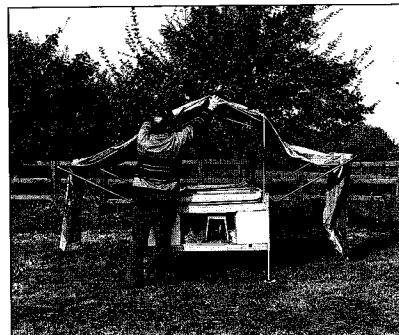

**4.** Repeat for the offside roof support frames. Then connect the two hinged arms to form the centre roof support frame.

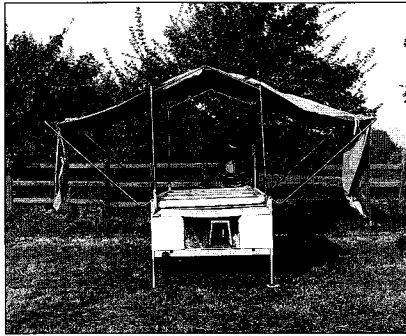

5. Extend the four cabin support poles at the front and back of the trailer. Locate the button clip in the centre of the bank of five holes. Adjust as necessary when pegging out.

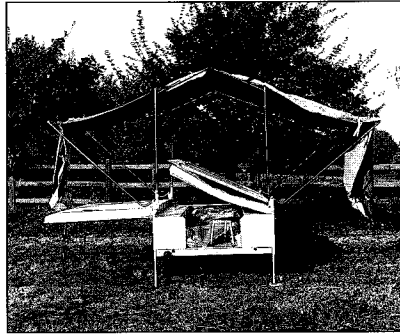

6. Fold over the left and then the right hand bed board and mattress. Adjust the bed legs as necessary.



7. Release the mattress retaining strap securing the inner tents and mattresses to the bed board. Clip the inner tents to the frame work, ensuring that the curved edge of each clip faces down. i.e. away from the canvas.



8. Pull down the walls of the cabin canvas.



9. Adjust cabin frame as necessary.

**SPECIAL NOTE:** When leaving the factory the inner tents are packed separately to avoid damage and soilage. Once fitted however, they can be left unclipped and folded with the mattresses.



## TRAILER TENTS EXTENSION FRAME - SYSTEMS A & B

The following instructions are intended as a step-by-step guide to help you erect your Conway Unit. Please read your Owners Manual thoroughly where you will find other helpful information within the section on Pitching.

### Systems A & B

1-8

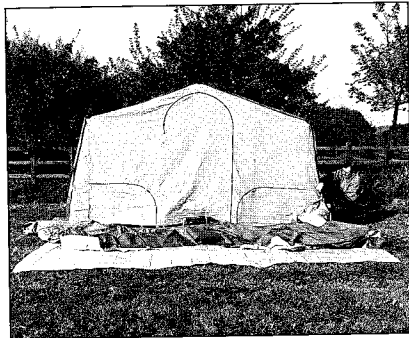

1. **A.** - Layout the extension canvas and fasten to the cabin by means of the matching zips.

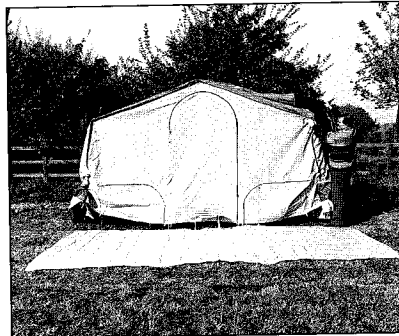

2. **A.** - Fold the extension canvas back over the cabin.  
**B.** - Having erected the cabin leave the integral extension canvas folded back over the cabin roof.



3. **A & B.** - Layout the extension frame as shown ensuring that all the spring sections are connected. See parts list diagram overleaf for a more detailed plan.

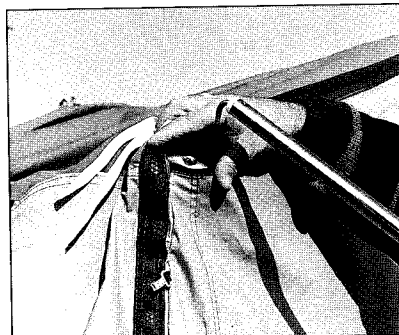

4. **A & B.** - Attach the three extension roof poles to the cabin frame.  
**NOTE:** The centre roof pole has a shorter hook.



**5. A & B.** - Connect the centre roof pole to the front 'A' frame. Repeat for the two side roof poles.



**6. A & B.** - Connect the centre leg to the 'A' frame and then pull forward the canvas from the cabin roof.



**7. A & B.** - Your frame type may vary now and you should either: (i) Locate spikes on front angle brackets through the corresponding eyelets in the canvas. **or** (ii) Locate the three angle brackets through the gussetts in the canvas and fit the three short canopy poles.



**8. A & B.** - Close all zips and adjust roof and leg poles and then peg out, beginning at the four corners. The canvas should always be kept as taut as possible. Now fit the curtains and roof lining.

**SPECIAL NOTE:** When pegging out ensure that the frame is adjusted to keep the canvas as taut as possible. When new, adjustment should be at maximum wherever ground conditions allow.

**INNER TENTS:** New Units - To avoid soiling during packing and transport the inner tents are packed separately. Once fitted they should remain in place.

For further tips and do's and don't's, when using your trailer tent see your owners handbook.

**BE PREPARED:** Always guy out your canvas for added stability.

**ROOF LININGS:** When fitting ensure all metal clips have the curved edge facing down to avoid chafing of canvas.



**CONWAY**

## TRAILER TENTS EXTENSION FRAME - SYSTEM C

The following instructions are intended as a step-by-step guide to help you erect your Conway Unit. Please read your Owners Manual thoroughly where you will find other helpful information within the section on Pitching.

### System C

1-9

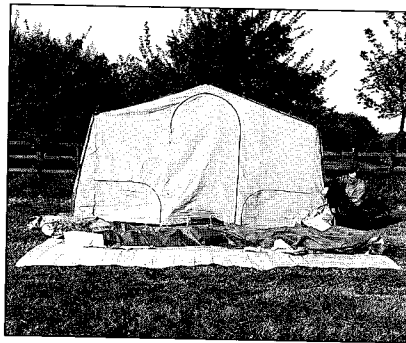

1. Layout the extension canvas and fasten to the cabin using the matching zips.

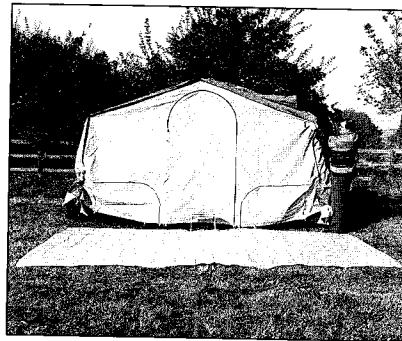

2. Throw the extension canvas back over the cabin roof.



3. Layout the short 1 metre annexe frame as shown ensuring all the spring sections are connected. See the parts list diagram overleaf for a more detailed plan.

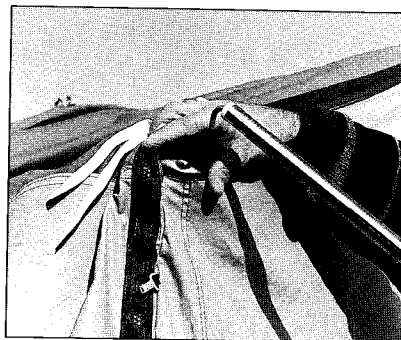

4. Attach the three short roof poles to the cabin frame.  
NOTE: The centre roof pole has a shorter hook.



**5.** Layout the main extension frame as shown. See the parts list diagram for a detailed plan.

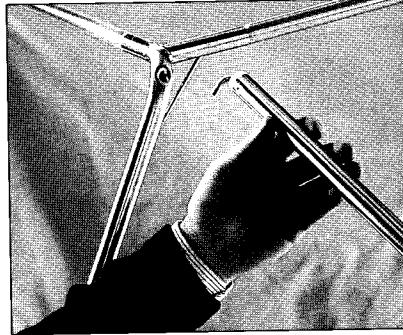

**6.** Connect the main extension frame to the short extension frame using the three roof support poles. The centre pole is fitted with the short hook.



**7.** Connect the three roof poles to the front 'A' frame then add the two centre legs. Pull forward the extension canvas from the cabin roof.

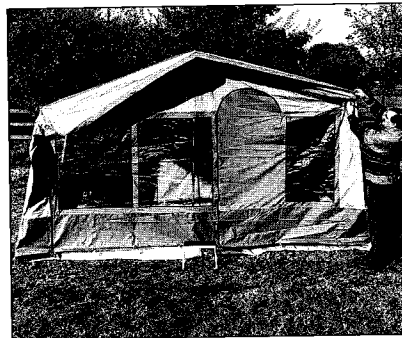

**8.** Depending on your frame type either: (i) Locate spikes on front angle brackets through corresponding eyelets in the canvas. or (ii) Locate angle brackets through the gussetts in the canvas and fit the three short stub canopy poles.

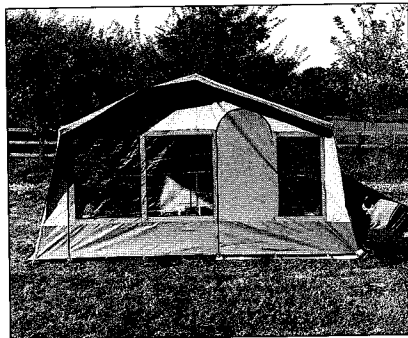

**9.** Ensure that all zips are closed and then adjust the roof poles and legs as necessary. Peg out, beginning at the corners and keeping the canvas as taut as possible. Fit the curtains and roof linings.



## TRAILER TENTS EXTENSION FRAME - SYSTEM D

The following instructions are intended as a step-by-step guide to help you erect your Conway Unit. Please read your Owners Manual thoroughly where you will find other helpful information within the section on Pitching.

### System D

1-9

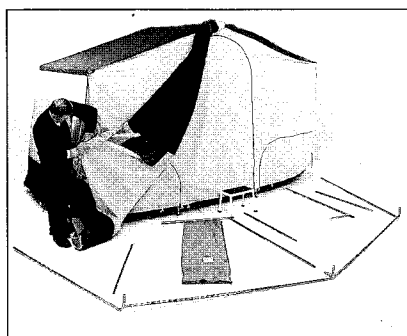

1. Layout the short 1 metre extension frame as shown. See the parts list diagram overleaf for a more detailed plan. Zip the 1 metre extension to the main cabin canvas and then fold back over the cabin roof.

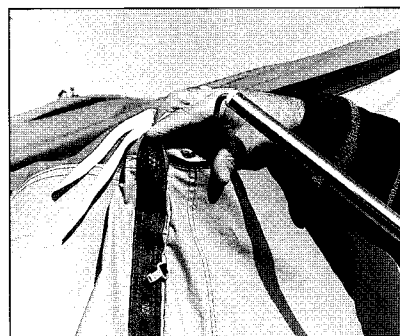

2. Connect the three annexe roof poles to the main cabin frame.  
NOTE: The centre cabin roof pole has a short hook.

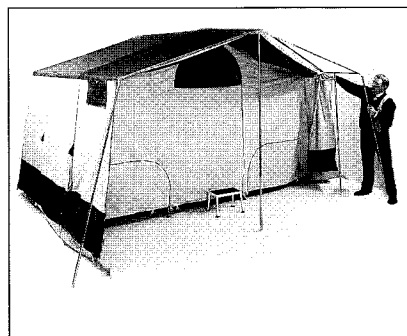

3. Connect the three roof poles to the front 'A' frame and attach the central leg then pull forward the canvas from the cabin roof.

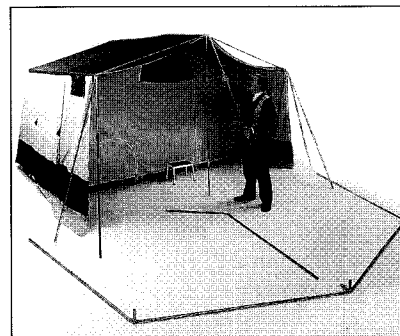

4. Layout the main extension frame and attach the roof poles to the short annexe frame.  
NOTE: The centre hook is again shorter. See the parts list diagram overleaf for a more detailed plan.

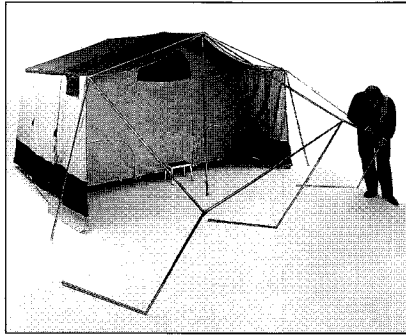

**5.** Connect the three roof poles to the front 'A' frame.  
**NOTE:** The lower leg section can be left 'broken' at this point to give a lower working height.

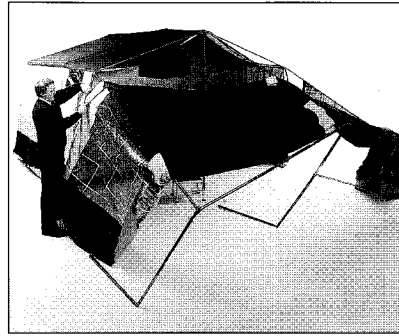

**6.** Unroll the main extension canvas onto the frame and attach to the 1metre annexe by means of the matching zips.

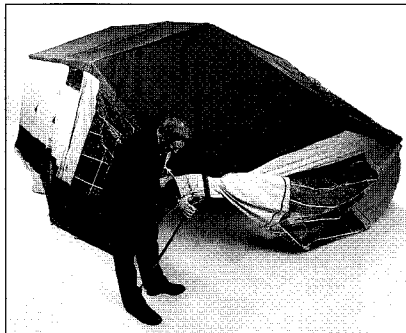

**7.** Pull the canvas forward over the front 'A' frame then dependant on your frame type either: (i) Locate spikes on the front angle bracket through the eyelets in the canvas, or (ii) Locate the three angle brackets through the gussetts in the canvas and fit three short canopy poles.

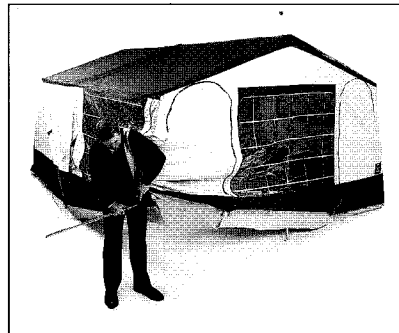

**8.** Connect the lower leg sections and lift the extension to its full height.

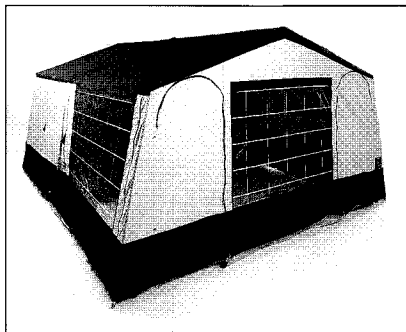

**9.** Adjust the roof and leg poles as necessary and then with all zips closed peg out beginning at the four corners. Fit the curtains and roof linings.

**SPECIAL NOTE:** For weekends or short stays you may wish to omit the intermediate 1metre extension. To attach the main extension canvas and frame directly to the cabin please follow the instructions set out for system 'A' extensions.





**CONWAY**

## TRAILER TENTS EXTENSION FRAME - SYSTEM E

The following instructions are intended as a step-by-step guide to help you erect your Conway Unit. Please read your Owners Manual thoroughly where you will find other helpful information within the section on Pitching.

### System E

1-10

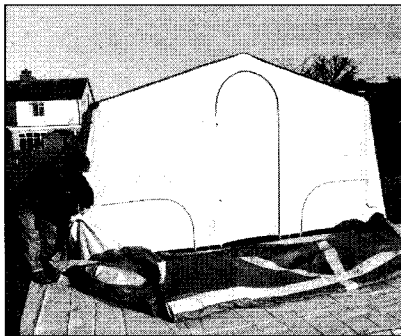

1. Layout the extension canvas and fasten to the cabin using the matching zips.

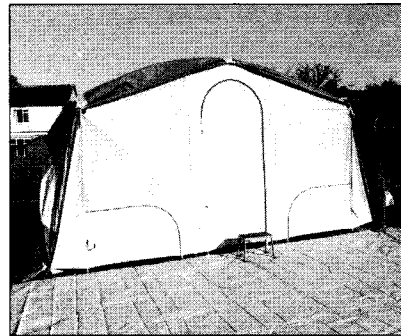

2. Throw the extension canvas back over the cabin roof.

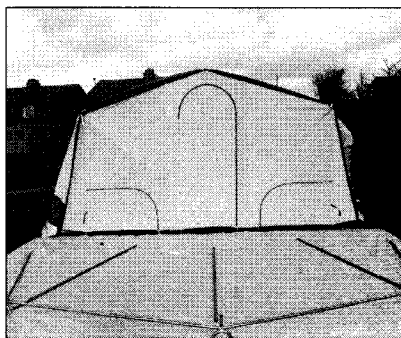

3. Find the three roof poles with adjustable locking screws. Place the hooked poles into these roof poles. These can now be kept connected for future use. Layout the centre frame as shown. See the parts list diagram overleaf for a more detailed plan.

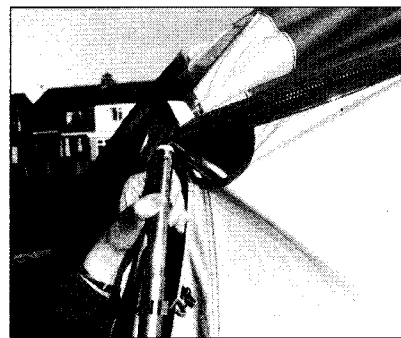

4. Attach the three roof poles to the cabin frame. **NOTE:** The centre roof pole has a shorter hook.

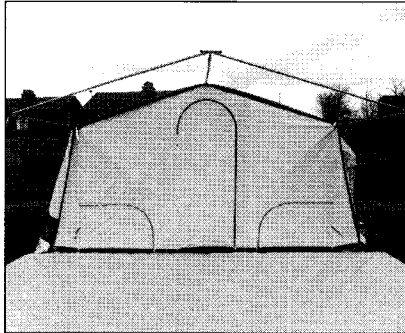

**5.** Lift up the centre frame and locate into the centre roof pole. Do likewise with the side roof poles.

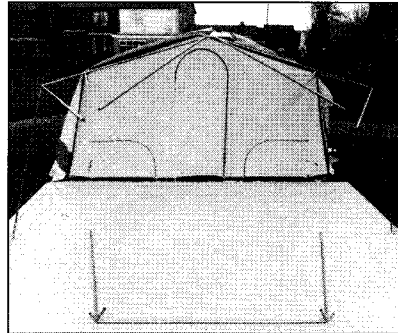

**6.** Layout the front extension frame as shown. Fit the four roof poles into the centre frame.

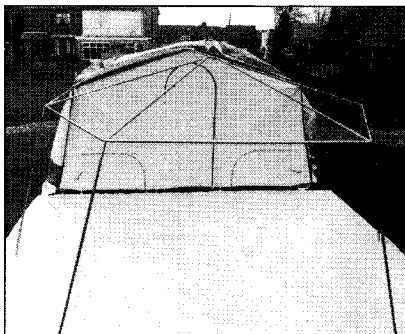

**7.** Connect the front frame to the four angled roof poles. Level the height of the frame by using the adjustable feet.



**8.** Pull forward the extension canvas from the cabin roof.



**9.** Pull the canvas fully over the frame and secure with six pegs, whilst you go inside to tension out the canvas.

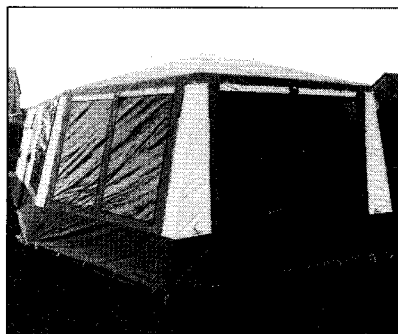

**10.** Tension the cabin roof poles with the adjustable screws until the canvas is fully taugth and located evenly on all the canvas rubbing strips. Fully peg out, ensuring that all the zips are closed.



**CONWAY**

## **EXTENSION FRAME PARTS - SYSTEM E**

**NOTE:** Due to model differences it is vital to quote the Model Type and both Model No. and Serial No. visible on the Trailer Chassis Plate fitted to the nearside front corner, when ordering Cabin or Extension Frame Parts.

### **EXTENSION FRAME PARTS**

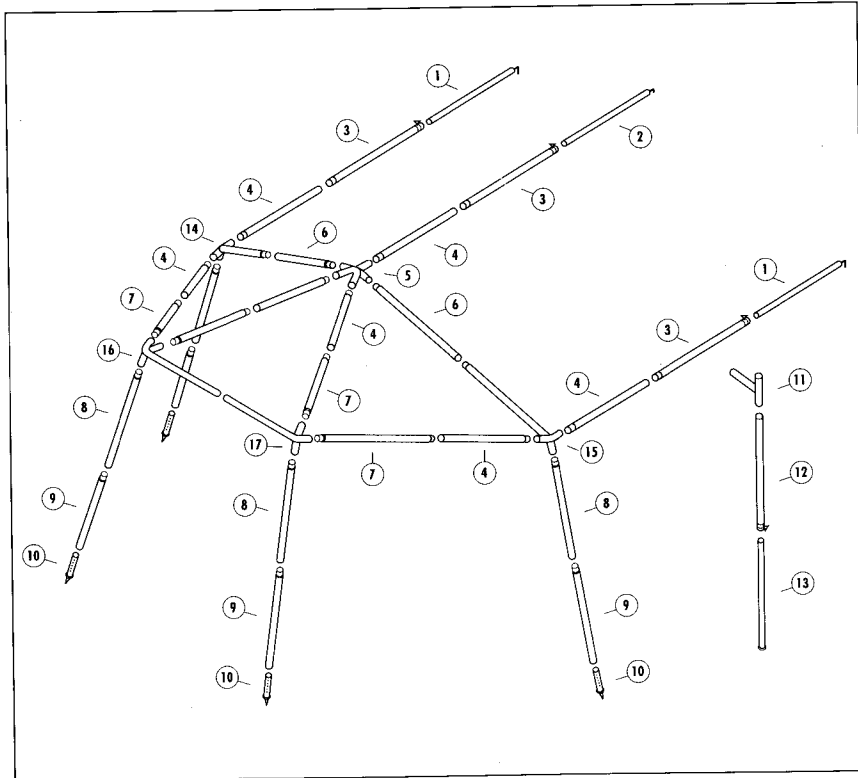

## EXTENSION FRAME PARTS - SYSTEM E



| REF NO. | QTY | DESCRIPTION                                     |
|---------|-----|---|
| 1       | 2   | ROOF POLE WITH LONG HOOK                        |
| 2       | 1   | ROOF POLE WITH SHORT HOOK                       |
| 3       | 3   | ROOF POLE WITH ADJUSTING SCREW                  |
| 4       | 7   | ROOF SUPPORT POLE                               |
| 5       | 1   | CENTRE 5 - WAY BRANCH                           |
| 6       | 2   | CENTRE BRANCH POLE                              |
| 7       | 4   | FRONT ROOF POLE (DOUBLE SWAGE)                  |
| 8       | 4   | UPPER SUPPORT LEG                               |
| 9       | 4   | LOWER SUPPORT LEG                               |
| 10      | 4   | ADJUSTABLE FOOT                                 |
| 11      | 1   | UPPER WARDROBE POLE                             |
| 12      | 1   | WARDROBE ADJUSTER POLE                          |
| 13      | 1   | WARDROBE LEG POLE                               |
| 14      | 1   | REAR CORNER BRANCH LEFT HAND - 4 - WAY BRANCH   |
| 15      | 1   | REAR CORNER BRANCH RIGHT HAND - 4 - WAY BRANCH  |
| 16      | 1   | FRONT CORNER BRANCH LEFT HAND - 4 - WAY BRANCH  |
| 17      | 1   | FRONT CORNER BRANCH RIGHT HAND - 4 - WAY BRANCH |



## CONWAY TRAILER TENTS - CABIN & EXTENSION FRAME PARTS

**NOTE:** Due to model differences it is vital to quote the Model Type and both Model No. and Serial No. visible on the Trailer Chassis Plate fitted to the nearside front corner, when ordering Cabin or Extension Frame Parts.

### CABIN FRAME PARTS

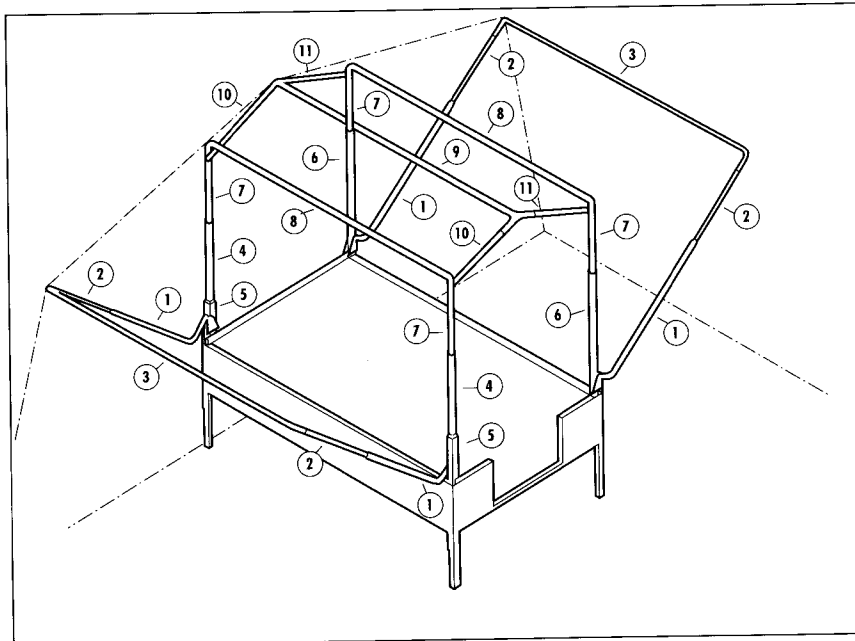

| REF NO. | QTY | DESCRIPTION   |
|---------|-----|---|
| 1       | 4   | LOWER CABIN POLE  |
| 2       | 4   | UPPER CABIN POLE - LEFT & RIGHT HAND                          |
| 3       | 2   | CABIN ROOF POLE - LEFT & RIGHT HAND                           |
| 4       | 2   | LOWER CENTRAL CABIN POLE - LEFT HAND FRONT & LEFT HAND REAR   |
| 5       | 2   | POLE CHANNEL  |
| 6       | 2   | LOWER CENTRAL CABIN POLE - RIGHT HAND REAR & RIGHT HAND FRONT |
| 7       | 4   | UPPER CENTRAL CABIN POLE - LEFT & RIGHT HAND FRONT & REAR     |
| 8       | 2   | CENTRAL CABIN ROOF POLE - LEFT HAND & RIGHT HAND              |
| 9       | 1   | CABIN RIDGE POLE  |
| 10      | 2   | RIDGE POLE TIE PIECE WITH BUTTON CLIP - LEFT HAND             |
| 11      | 2   | RIDGE POLE TIE PIECE WITHOUT BUTTON CLIP - RIGHT HAND         |

## EXTENSION FRAME PARTS

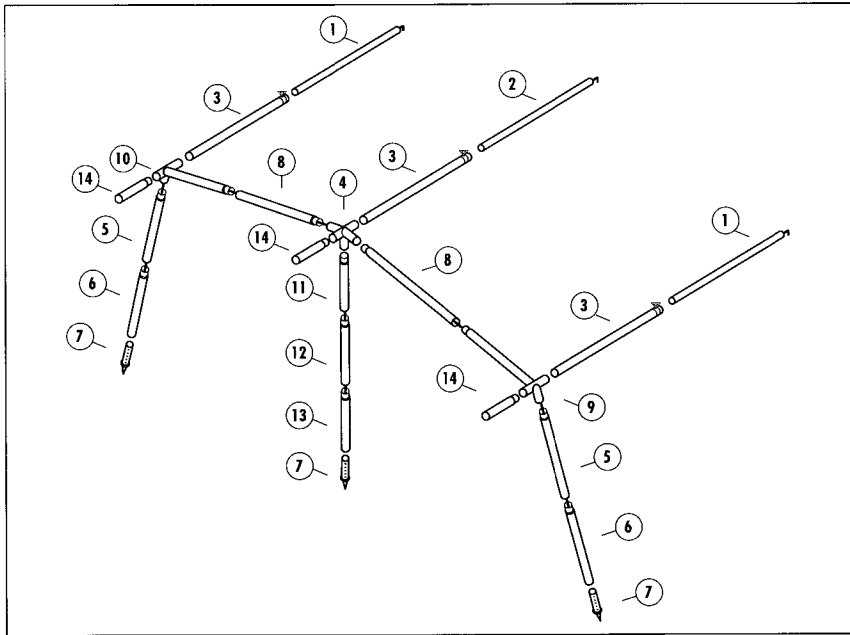

| REF NO. | QTY | DESCRIPTION                                    |
|---------|-----|--|
| 1       | 2   | ROOF POLE WITH LONG HOOK                       |
| 2       | 1   | ROOF POLE WITH SHORT HOOK                      |
| 3       | 3   | ROOF POLE WITH ADJUSTING SCREW                 |
| * 4     | 1   | CENTRE 5 - WAY BRANCH OR 4 - WAY BRANCH        |
| 5       | 2   | UPPER SUPPORT LEG                              |
| 6       | 2   | LOWER SUPPORT LEG                              |
| 7       | 3   | ADJUSTABLE FOOT                                |
| 8       | 2   | CENTRE BRANCH POLE                             |
| * 9     | 1   | CORNER BRANCH RIGHT HAND - 3 OR 4 - WAY BRANCH |
| * 10    | 1   | CORNER BRANCH LEFT HAND - 3 OR 4 - WAY BRANCH  |
| 11      | 1   | UPPER SUPPORT LEG (CENTRE)                     |
| 12      | 1   | MIDDLE SUPPORT LEG (CENTRE)                    |
| 13      | 1   | LOWER SUPPORT LEG (CENTRE)                     |
| 14      | 3   | STUB CANOPY POLE (PEAK CANOPY MODELS ONLY)     |

\* - These Branches will be either "SPIKED" - Flat Front or "STUB" Poles - Peak Canopy type depending on Model.

**MIDSECTION ANNEXE FRAME PARTS (if applicable)**

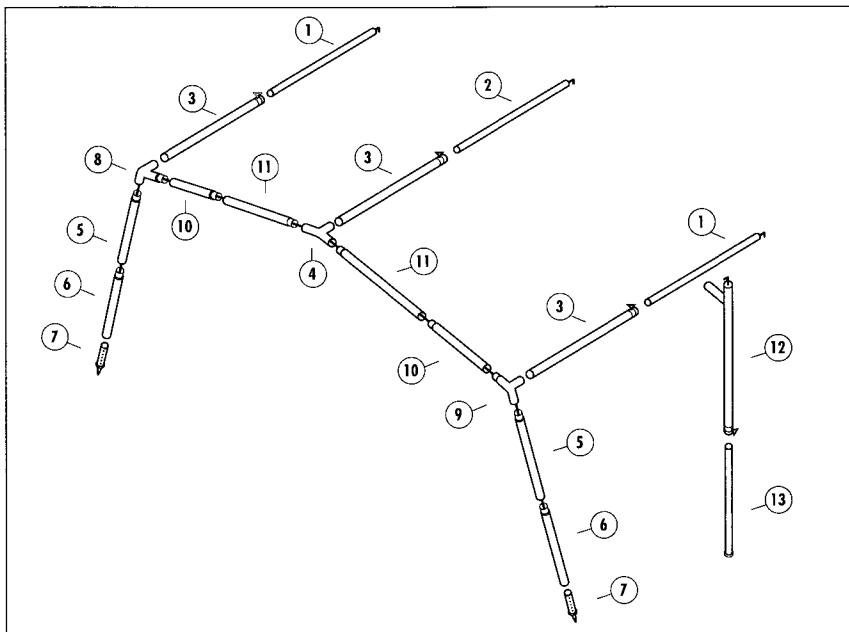

| REF NO. | QTY | DESCRIPTION                              |
|---------|-----|--|
| 1       | 2   | ROOF POLE WITH LONG HOOK                 |
| 2       | 1   | ROOF POLE WITH SHORT HOOK                |
| 3       | 3   | ROOF POLE WITH ADJUSTING SCREW           |
| * 4     | 1   | CENTRE 3 - WAY BRANCH OR 4 - WAY         |
| 5       | 2   | UPPER CORNER BRANCH                      |
| 6       | 2   | LOWER SUPPORT LEG                        |
| 7       | 2   | ADJUSTABLE FOOT                          |
| * 8     | 1   | CORNER BRANCH - LEFT HAND - 3 OR 4 - WAY |
| * 9     | 1   | CORNER BRANCH RIGHT HAND - 3 OR 4 - WAY  |
| 10      | 2   | CORNER BRANCH POLE                       |
| 11      | 2   | CENTRE BRANCH POLE                       |
| 12      | 1   | UPPER WARDROBE POLE                      |
| 13      | 1   | LOWER WARDROBE POLE                      |

\* - These Branches will be either 3 - WAY "HOOK-IN" or 4 - WAY "STUB" type depending on Model.



CONWAY

TRAILER TENTS - BODY & KITCHEN PARTS

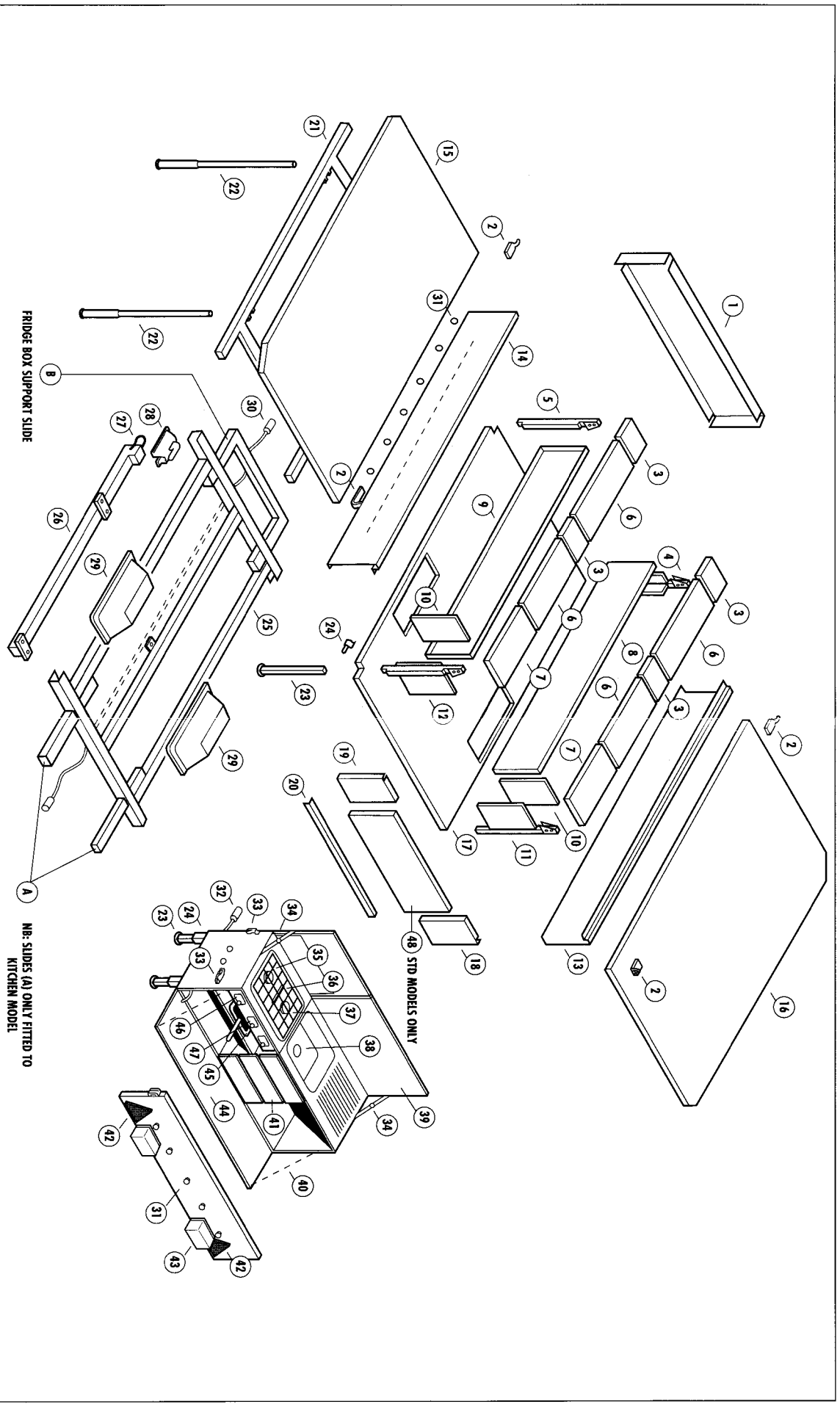





CONWAY

**CABIN BODY PARTS**

| REF NO. | QTY | DESCRIPTION                                     |
|---------|-----|---|
| 1       | 1   | TRAILER FRONT PANEL                             |
| 2       | 4   | HINGES - LEFT & RIGHT HAND, LARGE & SMALL CRANK |
| 3       | 4   | LOCKER FIXED PIECES                             |
| 4       | 1   | CORNER POST - RIGHT HAND FRONT                  |
| 5       | 1   | CORNER POST - LEFT HAND FRONT                   |
| 6       | 4   | LOCKER LIDS - LEFT & RIGHT HAND                 |
| 7       | 2   | LOCKER END PIECES - LEFT & RIGHT HAND           |
| 8       | 1   | LOCKER INSIDE PANEL - RIGHT HAND                |
| 9       | 1   | LOCKER INSIDE PANEL - LEFT HAND                 |
| 10      | 2   | LOCKER INSIDE END PANEL - LEFT & RIGHT HAND     |
| 11      | 1   | CORNER POST - RIGHT HAND REAR                   |
| 12      | 1   | CORNER POST - LEFT HAND REAR                    |
| 13      | 1   | TRAILER SIDE PANEL - RIGHT HAND                 |
| 14      | 1   | TRAILER SIDE PANEL - LEFT HAND                  |
| 15      | 1   | BED BOARD - LEFT HAND                           |
| 16      | 1   | BED BOARD - RIGHT HAND                          |
| 17      | 1   | TRAILER BASEBOARD                               |
| 18      | 1   | RIGHT HAND REAR PANEL                           |
| 19      | 1   | LEFT HAND REAR PANEL                            |
| 20      | 1   | CARPET TRAP                                     |
| 21      | 2   | BED BOARD STIFFENING FRAME                      |
| 22      | 2   | BED SUPPORT LEGS                                |
| 23      | 4   | TRAILER SUPPORT JACK LEGS                       |
| 24      | 8   | TRAILER SUPPORT JACK LEG LOCKING SCREW          |
| 25      | 1   | CHASSIS   |
| 26      | 1   | DRAWBAR   |
| 27      | 1   | SAFETY CABLE & 'U' BOLT                         |
| 28      | 1   | 50mm COUPLING - NON BRAKED TRAILER              |
| 29      | 2   | WHEEL BOX - RIGHT & LEFT HAND                   |
| 30      | 1   | SEVEN PIN PLUG & WIRING HARNESS                 |
| 31      | 28  | COVER ANCHORAGE BUTTONS                         |
| 48      | 1   | REAR DOOR (STD MODELS ONLY)                     |

**IMPORTANT** - When requesting Replacement Parts always quote:  
MODEL and CHASSIS PLATE Number.



CONWAY

**CABIN KITCHEN PARTS (Deluxe Model only)**

| REF NO. | QTY | DESCRIPTION                          |
|---------|-----|--------------------------------------|
| 32      | 1   | SEVEN-PIN PLUG                       |
| 33      | 4   | PROTEX FASTENER OR ADJUSTABLE OTOP   |
| 34      | 2   | KITCHEN TOP STAY - RIGHT & LEFT HAND |
| 35      | 1   | COOKER TOP GRILL - PAN SUPPORT       |
| 36      | 1   | CENTRE GRILL                         |
| 37      | 2   | SIDE BURNER                          |
| 38      | 1   | SINK WASTE & PLUG                    |
| 39      | 1/1 | KITCHEN TOP LARGE/SMALL              |
| 40      | 2   | SUPPORT CHAIN 28" LONG               |
| 41      | 2   | DRAWER                               |
| 42      | 2   | REFLECTOR                            |
| 43      | 2   | REAR LIGHT                           |
| 44      | 1   | REAR FLAP                            |
| 45      | 1   | GRILL PAN & WIRE TRIKET              |
| 46      | 2   | SIDE BURNER CONTROL KNOB             |
| 47      | 1   | GRILL CONTROL KNOB                   |