



TRAILER TENTS CABIN ERECTING INSTRUCTIONS

2002 - MARECHAL, CLASSIC TRIO, VISION, SPIRIT
2001 - CABANON, CONTINENTAL, MIRAGE, CENTURY, CLASSIC TRIO

The following instructions are intended as a step-by-step guide to help you erect your Conway Unit. Please read your Owners Manual thoroughly where you will find other helpful information within the section on pitching.

IMPORTANT NOTE: MARECHAL AND CABANON POLES ARE NOT INTERCHANGABLE.



1. Position trailer on as level ground as possible. Release the four corner steadies and adjust as necessary. Use the four plywood pads provided.

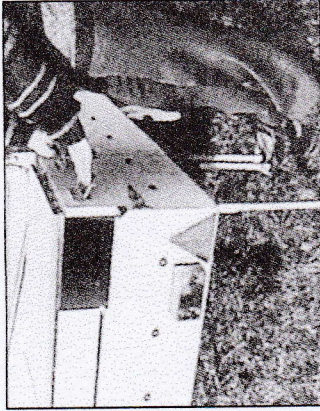

2. Unclip and remove the cover.
DELUXE MODELS: Unfasten and remove the kitchen unit. Do not forget to unclip the seven pin plug under the kitchen.

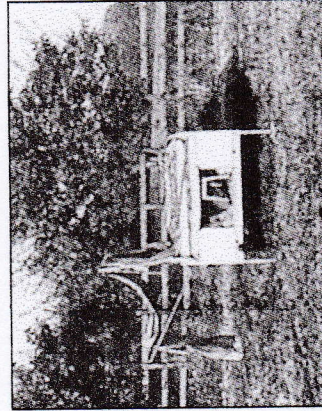

3. Swing over the near side roof support frames.

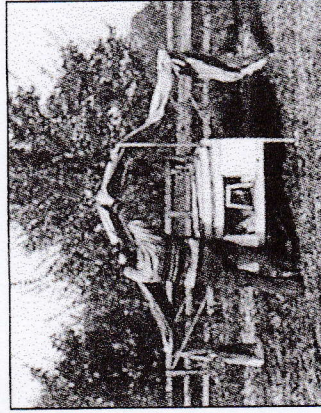

4. Repeat for the offside roof support frames. Then connect the two hinged arms to form the centre roof support frame.

TRAILER TENTS CABIN ERECTING INSTRUCTIONS - CONTINUED

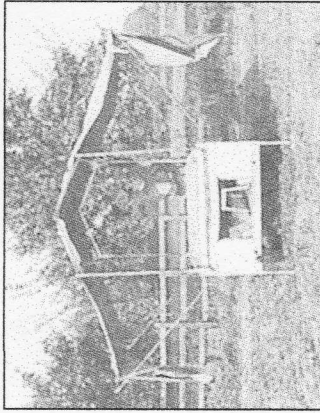

5 . Extend the four cabin support poles at the front and back of the trailer. Locate the button clip in the centre of the bank of five holes. Adjust as necessary when pegging out.

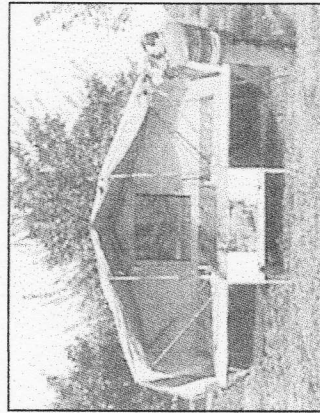

8 . Pull down the walls of the cabin canvas.

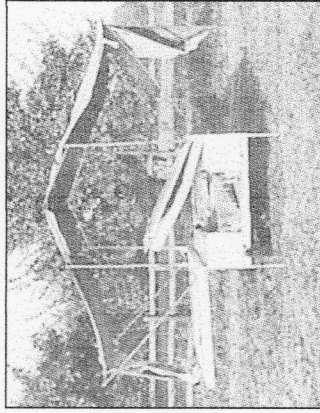

6 . Fold over the left and then the right hand bed board mattress. Adjust the bed legs as necessary.

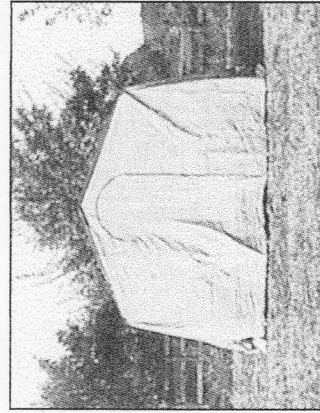

9 . Adjust cabin frame as necessary.



7 . Release the mattress retaining strip securing the inner tents and mattresses to the bed board. Clip the inner tents to the frame work, ensuring that the curved edge of each clip faces down. i.e. away from the canvas.

SPECIAL NOTE: When leaving the factory the inner tents are packed separately to avoid damage and soilage. Once fitted however, they can be left unclipped and folded with the mattresses.



TRAILER TENTS EXTENSION ERECTION

2001 CABANON, CENTURY/MIRAGE - 2002 MARECHAL, VISION/SPIRIT

CENTURY / MIRAGE

The following instructions are intended as a step-by-step guide to help you erect your Conway Unit. Please read your Owners Manual thoroughly where you will find other helpful information within the section on Pitching.

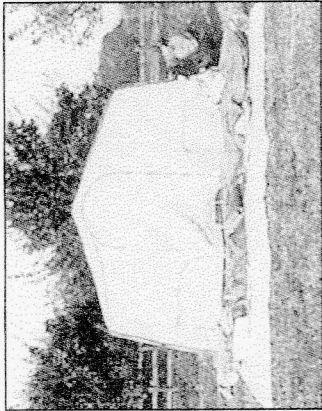

1. Layout the extension canvas and fasten to the cabin using the matching zips.

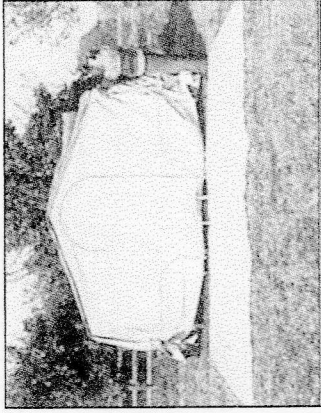

2. Throw the extension canvas over the cabin roof.

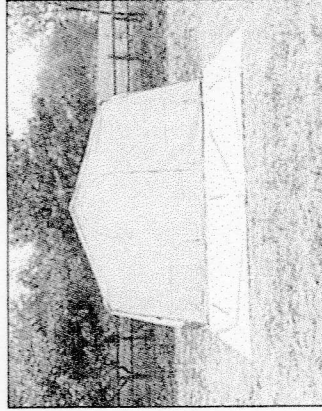

3. Layout the short 1 metre annex frame as shown ensuring all the spring sections are connected. See the parts list diagram overleaf for a more detailed plan.

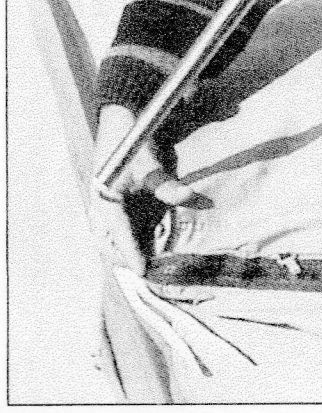

4. Attach the three short roof poles to the cabin frame.
NOTE: The centre roof pole has a shorter hook, except on Marechal all 3 hooks are same size.

TRAILER TENTS EXTENSION ERECTION

2001 CABANON, CENTURY/MIRAGE - 2002 MARECHAL, VISION/SPIRIT CONTINUED

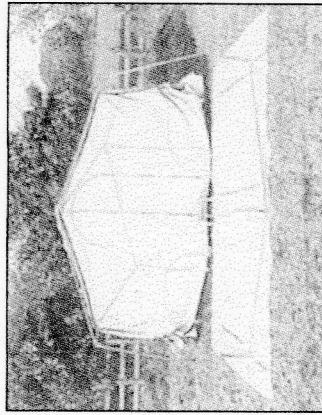

5. Layout the main extension frame as shown. See the parts list diagram for a detailed plan.

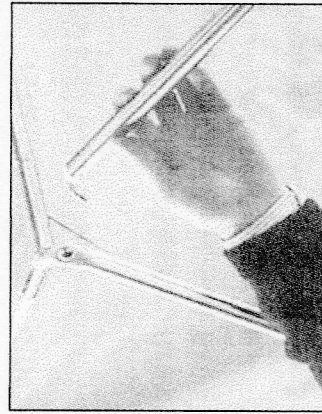

6. Connect the main extension frame to the short extension frame using the three roof support poles. The centre pole is fitted with the short hook.

Note: Marechal frames have male/female fitting.

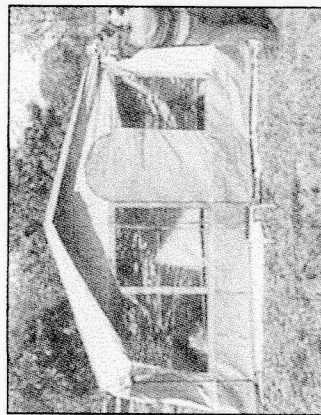

8. Depending on your frame type either: (i) Locate spikes on front angle brackets through corresponding eyelets in the canvas, or (ii) Locate angle brackets through the gussets in the canvas and fit the three short stub canopy poles.

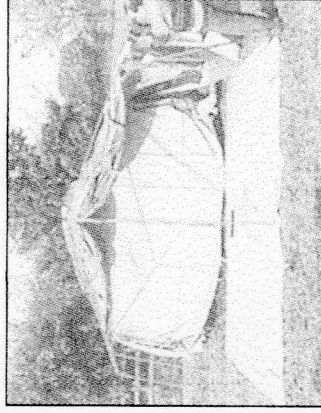

7. Connect the three roof poles to the front 'A' frame then add the two centre legs. Pull forward the extension canvas from the cabin roof.

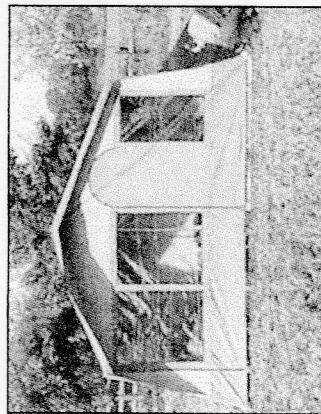

9. Ensure that all zips are closed and then adjust the roof poles and legs as necessary. Peg out, beginning at the corners and keeping the canvas as taut as possible. Fit the curtains and roof linings.



Freedom for Life

2002 MARECHAL SPIRIT EXTENSION FRAME PARTS (440 X 300)

NOTE: Due to model differences it is vital to quote the Model Type and both Model No. and Serial No. visible on the Trailer Chassis Plate fitted to the nearside front when ordering Cabin or Extension Frame Parts.

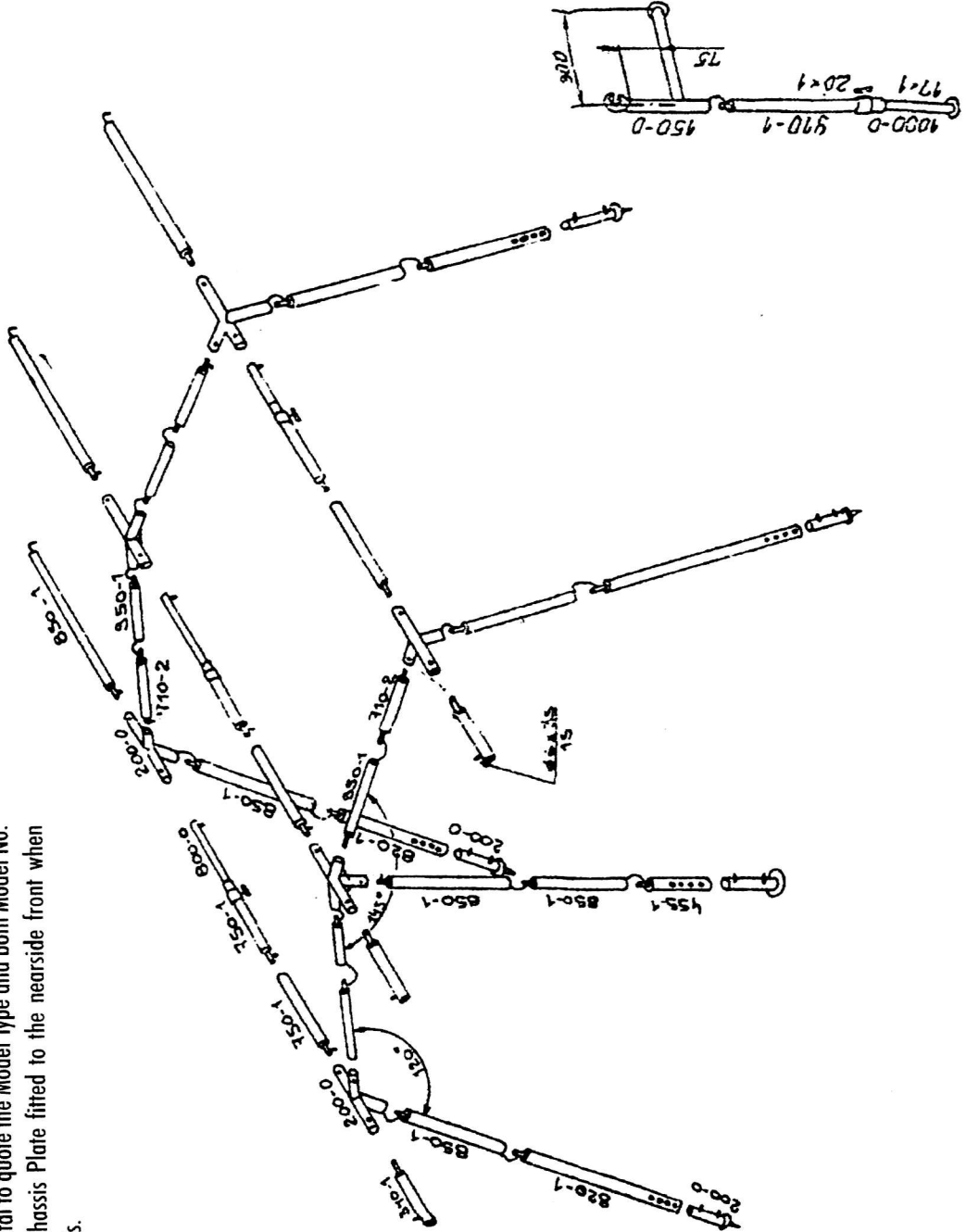



TRAILER TENTS EXTENSION ERECTING INSTRUCTIONS

2002 MARECHAL CLASSIC TRIO, VISION, SPIRIT - CABIN FRAME PARTS

2001 CABANON CLASSIC TRIO - CABIN FRAME PARTS

NOTE: Due to model differences it is vital to quote the Model Type and both Model No. and Serial No. visible on the Trailer Chassis Plate fitted to the nearside front when ordering Cabin or Extension Frame Parts.

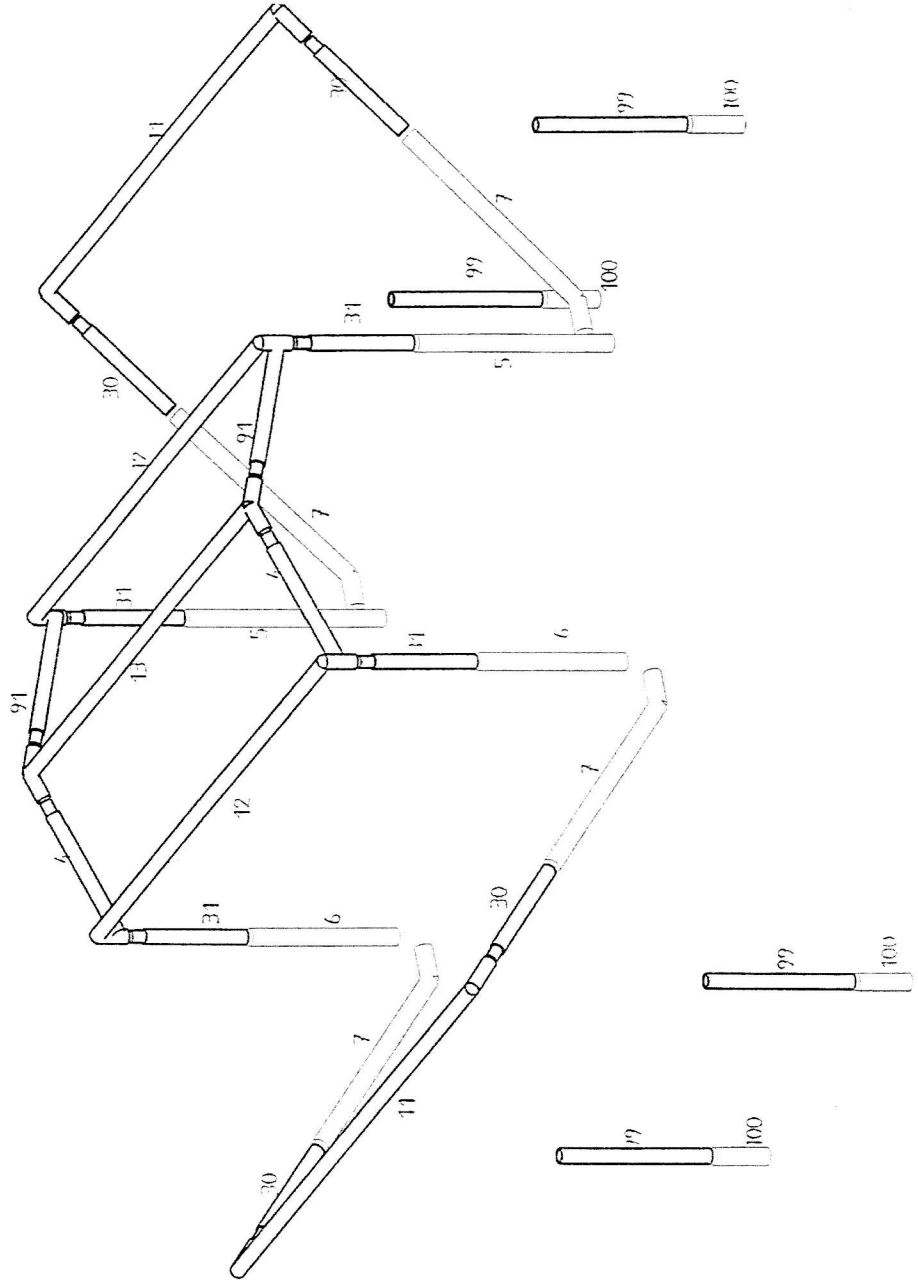

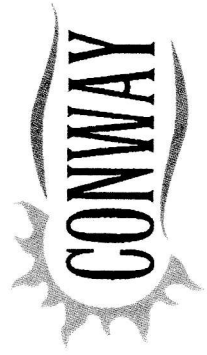

F r e e d o m f o r L i f e

SUN CANOPY (OPTIONAL) AND SIDE WALLS (OPTIONAL) - TRAILER TENTS

DELUXE TYPE

Canvas roof with peggable corner "legs". Zips to cabin or ties to extension frame front.

Frame:- "Gable-end" type front frame with 1 centre and 2 side roof poles. Optional side walls can be fitted to this type.

STANDARD TYPE

Canvas roof section only. Ties to front of extension frame only. (side walls n/a).

Frame "Gable-end" type front frame with 1 centre hook-on pole only.

ERECTION SEQUENCES

e.g. Mirage deluxe type. (see also frame drawing)

- 1 Release tension on extension roof poles and remove 3 spiked peak canopy poles (No's 9). Replace these with sun canopy poles (No's 9) (spiked) and 8 (adjustable). Place sun canopy canvas on these poles and attach under the peak canopy to the front of the extension frame, using the sewn in tie tapes (3).

- 2 Fit the side roof poles through the sleeves in the sun canopy roof canvas and ensure spikes are through both sets of eyelets in canvas. Certain models may have Velcro on sleeves.

- 3 Fit 2 halves of spring linked front frame through front sleeves in sun canopy canvas and ensure spikes are through both sets of eyelets in canvas.

- 4 Re-tension extension roof poles then tension sun canopy frame roof poles. Using the pegs and guy lines provided, peg down the canvas legs and guy out the front. It is recommended that guy lines be used on all occasions.

Note: When fitting sun canopy to cabin unit alone use hooked poles (No's 10) in place of No's 9, with the short hook in the centre and long hooks at the sides, hooking into the cabin frame. The sun canopy canvas will then zip to the cabin canvas.

STANDARD TYPES

The single centre roof pole will simply hook below the peak canopy, onto the extension frame front, through the hole in the canvas front wall, adjacent to the extension frame centre leg.

Frame Drawings:

- 1 Voyager (std)
- 2 Continental (std)
- 3 Classic Trio, Vision, Spirit. (see also page 80)
- 4 Century & Mirage deluxe
- 5 Classic (std)

Sun canopy side walls-fitting:

- 1 Note that the side wall fits to either end, "inside" of the sun canopy with mudwall "inside" also.
- 2 Clip the 3 x metal clips (top) to the side roof poles of the sun canopy frame and adjust position if necessary to tie the end tie tapes.
- 3 Clip the outer metal clips only to the sun canopy frame leg and peg down using the pegs provided.

Note: Marechal and Cabanon poles are not interchangeable.

SUN CANOPY FRAME-PARTS 440 MODELS
2002 MARECHAL CLASSIC TRIO VISION, SPIRIT 440
2001 CABANON CLASSIC TRIO

NOTE: Due to model differences it is vital to quote the Model Type and both Model No. and Serial No. visible on the Trailer Chassis Plate fitted to the nearside front when ordering Cabin or Extension Frame Parts.

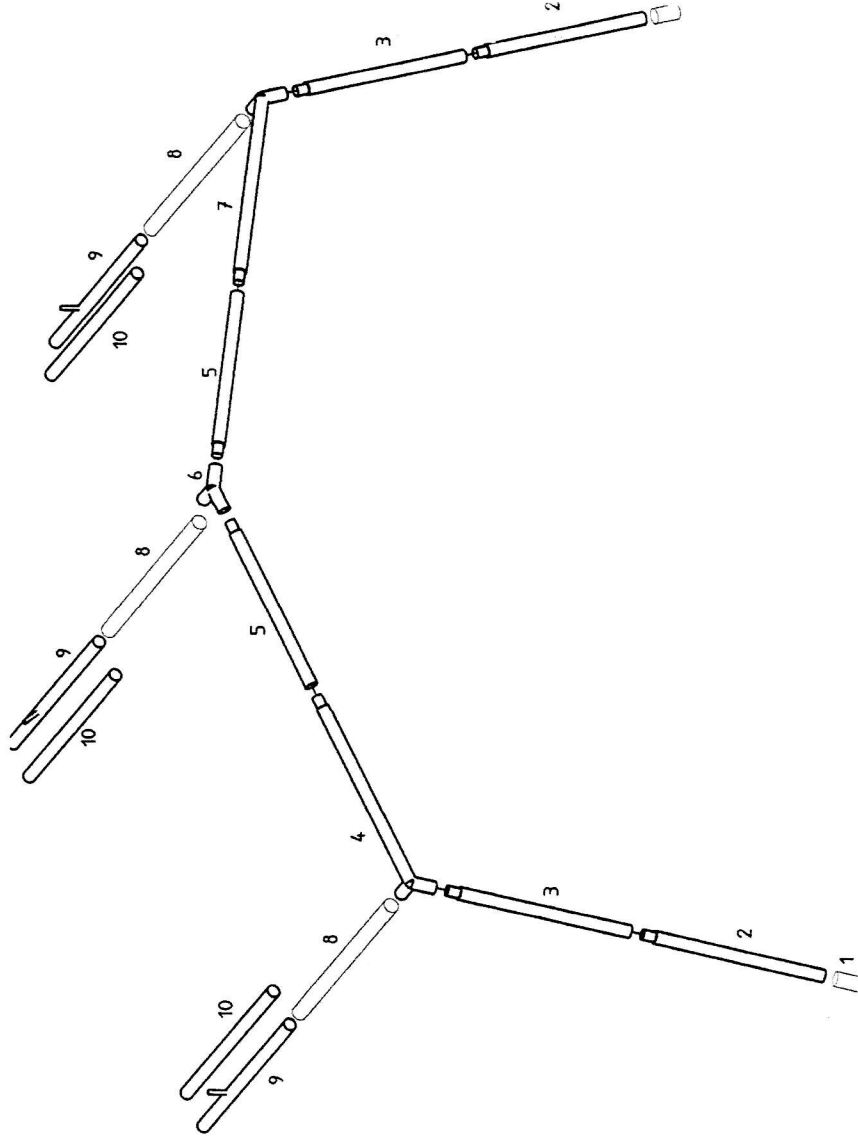

TRAILER TENTS - BODY & KITCHEN PARTS

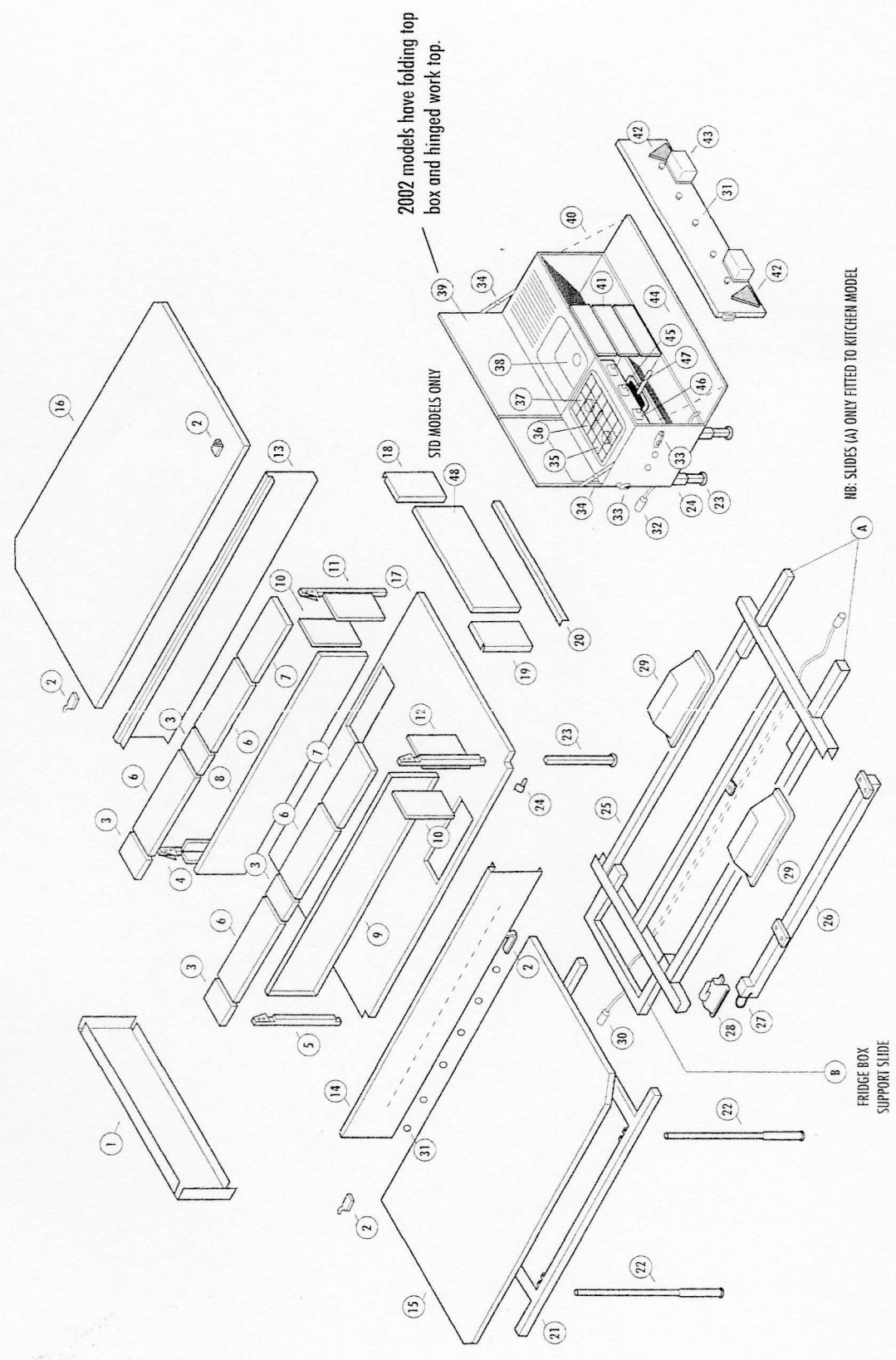



TRAILER TENTS - CABIN BODY PARTS

REF NO.	QTY	DESCRIPTION
1	1	TRAILER FRONT PANEL
2	4	HINGES - LEFT & RIGHT HAND, LARGE & SMALL CRANK
3	4	LOCKER FIXED PIECES
4	1	CORNER POST - RIGHT HAND FRONT
5	1	CORNER POST - LEFT HAND FRONT
6	4	LOCKER LIDS - LEFT & RIGHT HAND
7	2	LOCKER END PIECES - LEFT & RIGHT HAND
8	1	LOCKER INSIDE PANEL - RIGHT HAND
9	1	LOCKER INSIDE PANEL - LEFT HAND
10	2	LOCKER INSIDE END PANEL - LEFT & RIGHT HAND
11	1	CORNER POST - RIGHT HAND REAR
12	1	CORNER POST - LEFT HAND REAR
13	1	TRAILER SIDE PANEL - RIGHT HAND
14	1	TRAILER SIDE PANEL - LEFT HAND
15	1	BED BOARD - LEFT HAND
16	1	BED BOARD - RIGHT HAND

REF NO.	QTY	DESCRIPTION
17	1	TRAILER BASEBOARD
18	1	RIGHT HAND REAR PANEL
19	1	LEFT HAND REAR PANEL
20	1	CARPET TRAP
21	2	BED BOARD STIFFENING FRAME
22	2	BED SUPPORT LEGS
23	4	TRAILER SUPPORT JACK LEGS
24	8	TRAILER SUPPORT JACK LEG LOCKING SCREW
25	1	CHASSIS
26	1	DRAWBAR
27	1	SAFETY CABLE & 'U' BOLT
28	1	50MM COUPLING - NON BRAKED TRAILER
29	2	WHEEL BOX - RIGHT & LEFT HAND
30	1	SEVEN PIN PLUG & WIRING HARNESS
31	28	COVER ANCHORAGE BUTTONS
48	1	REAR DOOR (STD MODELS ONLY)

IMPORTANT
When requesting replacement parts always quote: MODEL AND CHASSIS PLATE NUMBER



Freedom for Life

TRAILER TENTS

DE-LUXE KITCHEN PARTS (Deluxe Model only)

REF NO.	QTY	DESCRIPTION
32	1	SEVEN PIN PLUG
33	4	PROTEX FASTENER OR ADJUSTABLE OJOP
34	2	KITCHEN TOP STAY - RIGHT & LEFT HAND
35	1	COOKER TOP GRILL - PAN SUPPORT
36	1	CENTRE GRILL
37	2	SIDE BURNER
38	1	SINK WASTE & PLUG
39	1/1	KITCHEN TOP LARGE/SMALL
40	2	SUPPORT CHAIN 28" LONG
41	2	DRAWER
42	2	REFLECTOR
43	2	REAR LIGHT
44	1	REAR FLAP
45	1	GRILL PAN & WIRE TRIVET
46	2	SIDE BURNER CONTROL KNOB
47	1	GRILL CONTROL KNOB